



GET YOUR PRODUCTS FAST
Arani is committed to same day shipping on orders before 3pm*.

Date:	Project:
Prepared for:	Type:
Comments:	



LED HIGH BAY V3

IP65 | DIMMABLE



5 Years



Lifetime
50 000 hours



IP65
Suitable for use in wet locations



0-10V
Dimmable



SPECIFICATIONS

- Hook/Bracket Installation
- IP65 - Suitable for Wet Locations
- Robust Aluminium Casing
- Clear Polycarbonate Lens
- 6 ft Cord
- Beam Angle: 85°
- Colour Rendering Index: >80
- Functioning Temperature: -40°C to 45°C
- High Light Efficacy

AVAILABILITY

- 100W/150W/200W/240W
- 4000K / 5000K
- 120-277Vac / 347Vac
- 0-10V Dimmable
- Motion Sensor



*This icon indicates a STOCK item: Look for this Same Day Shipping icon below in 'Ordering Information' for products that ship on the same day (orders placed before 3pm) from Montreal, Quebec or Calgary, Alberta



IES File Available on Request



Hook

Compatible sensors (optional and sold separately) can be easily installed

Clear Polycarbonate

DIMENSIONS

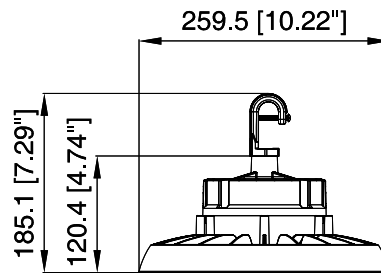

100W

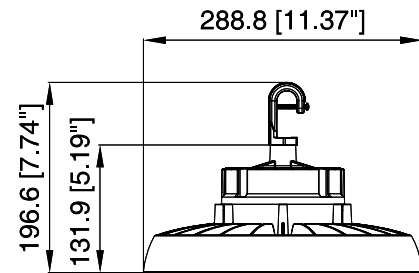

150W

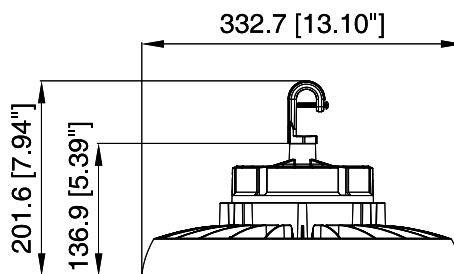



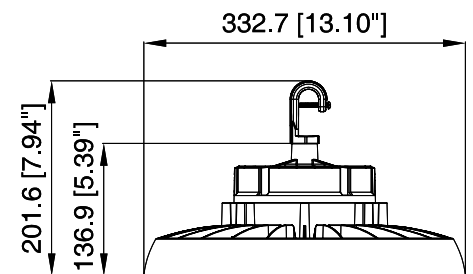











200W



240W

ORDERING INFORMATION

SERIES	POWER (WATTS)	EQUIVALENT TO (WATTS)	LUMENS	WEIGHT (LBS)	COLOR TEMP	INPUT VOLTAGE	PRODUCT ID	MODEL NUMBER	ORDERING NUMBER	
LED HIGH BAY V3	100W	200W MH	14000	5.4	4000K	100-277Vac	PL3NC47V6T7E	HIG12R0100W-85-H-40K-V3	HB-100W-40K-R-V3	
						347Vac	PL9NFCQBB72N	HIG12R0100W-85-H-HV-40K-V3	HB-100W-40K-R-V3-347V	
					5000K	100-277Vac	PL9BUYJT0FQN	HIG12R0100W-85-H-50K-V3	HB-100W-50K-R-V3	
						347Vac	PL4WAD215VBJ	HIG12R0100W-85-H-HV-50K-V3	HB-100W-50K-R-V3-347V	
	150W	330W MH	21000	7	4000K	100-277Vac	PL3EG62DDAP8	HIG12R0150W-85-H-40K-V3	HB-150W-40K-R-V3	
						347Vac	PLIN5975QROJ	HIG12R0150W-85-H-HV-40K-V3	HB-150W-40K-R-V3-347V	
					5000K	100-277Vac	PL8IVIXCUZBY	HIG12R0150W-85-H-50K-V3	HB-150W-50K-R-V3	
						347Vac	PL09N18TX715	HIG12R0150W-85-H-HV-50K-V3	HB-150W-50K-R-V3-347V	
	200W	400W MH	28000	9	4000K	100-277Vac	PL538560VOC7	HIG12R0200W-85-H-40K-V3	HB-200W-40K-R-V3	
						347Vac	PL7S3NNHESDL	HIG12R0200W-85-H-HV-40K-V3	HB-200W-40K-R-V3-347V	
					5000K	100-277Vac	PLG1YA3T7W4H	HIG12R0200W-85-H-50K-V3	HB-200W-50K-R-V3	
						347Vac	PL6GD75VA3KX	HIG12R0200W-85-H-HV-50K-V3	HB-200W-50K-R-V3-347V	
240W	750W MH	33600	11.2	5000K	100-277Vac	PLEKDESRW4WN	HIG12R0240W-85-H-50K-V3	HB-240W-50K-R-V3		
					347Vac	PL0H1NSPRSX3	HIG12R0240W-85-H-HV-50K-V3	HB-240W-50K-R-V3-347V		



Bracket for High Bay V3
HB-BR-xxW-V3
Sold Separately

HB-100W-xxK-R-V3

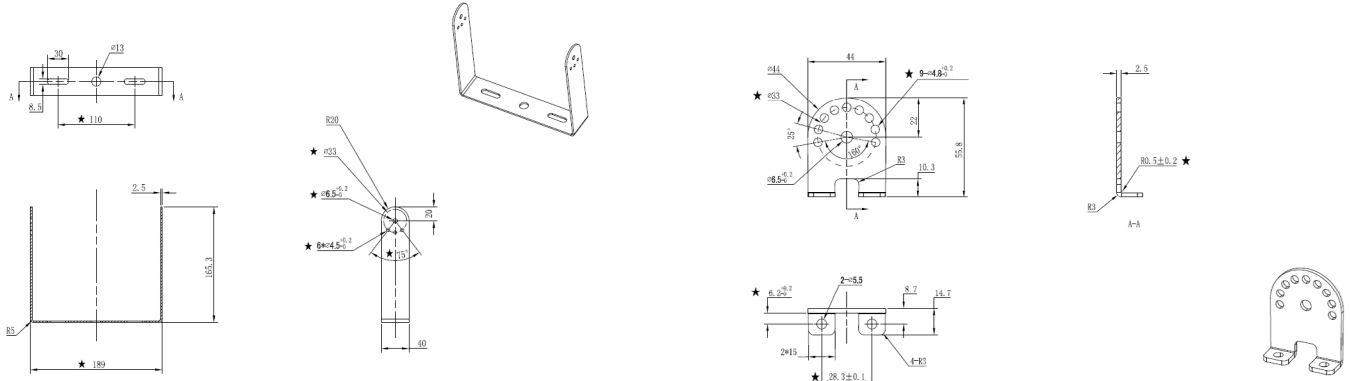

HB-150W-xxK-R-V3

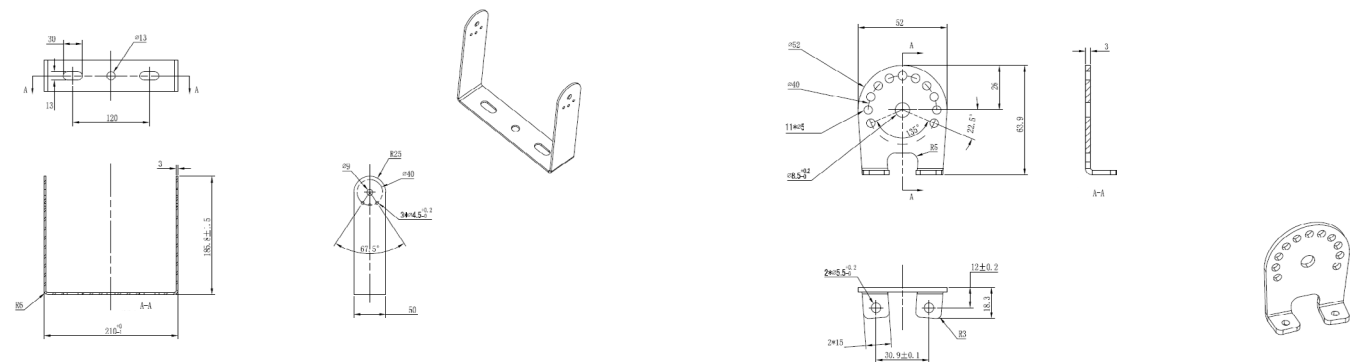

HB-200W-xxK-R-V3 / HB-240W-xxK-R-V3

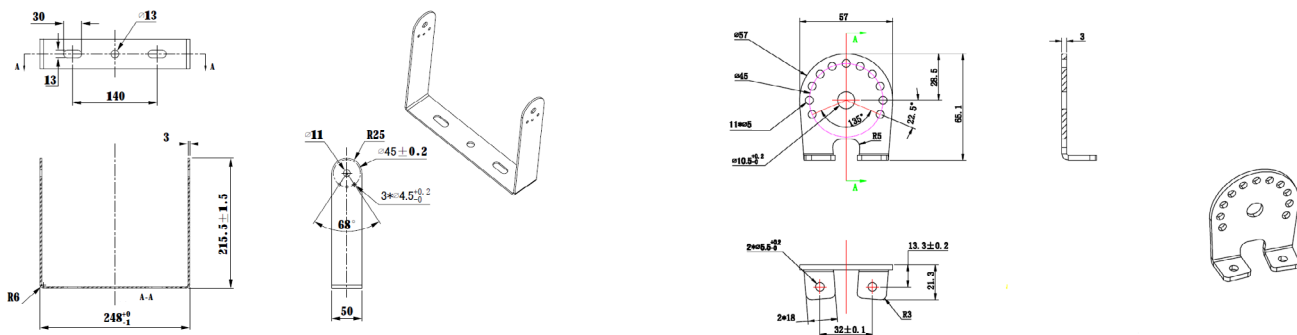

SERIES	COMPATIBLE WITH	DIMENSIONS	ORDERING NUMBER
BRACKET FOR LED HIGH BAY V3	100W HIGH BAY V3	189 x 165.3 x 40 mm	HB-BR-100W-V3
	150W HIGH BAY V3	210 x 185.8 x 50 mm	HB-BR-150W-V3
	200W 240W HIGH BAY V3	248 x 215.5 x 50 mm	HB-BR-200-240W-V3

ACCESSORIES



12V High-Frequency (Microwave)
Motion Sensor
HB-MS-V3
Sold Separately

FEATURES

- Dim Control Output: 0-10V, max, 25mA sinking current
- HF System: 5.8GHz ± 75MHz
- Transmission Power: <0.2m W
- Detection Radius: 20%/50%/75%100% (1-8m)
- Mounting Height: Max 50ft. (15 meters)
- Operating Temperature: -20°C to 60°C
- Time Setting: 10s/ 1min/5min/10min/15min/20min/30min/60min
- Light Control: 24H/ 10LUX/ 30LUX/ 50LUX

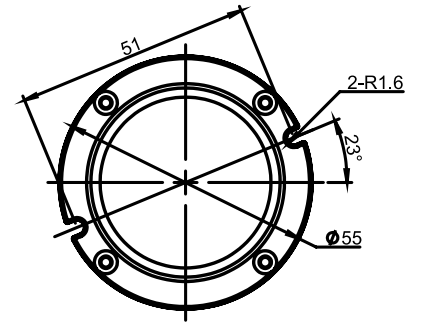
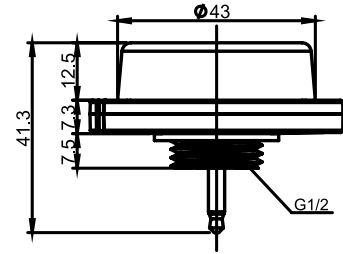



12V PIR Motion Sensor
HB-PIR-V3
Sold Separately

FEATURES

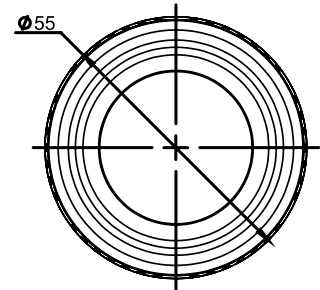
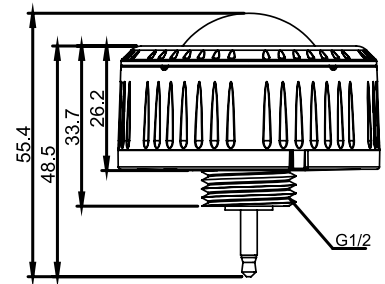
- Dim Control Output: 0-10V, max, 25mA sinking current
- Remote Range: 50ft. (15m) indoor, no backlight
- Detection Radius: 20%/50%/75%100% (1-8m)
- Mounting Height: Max 40ft. (12 meters)
- Operating Temperature: -20°C to 60°C
- Time Setting: 10s/ 1min/5min/10min/15min/20min/30min/60min
- Light Control: 24H/ 10LUX/ 30LUX/ 50LUX



SERIES	COMPATIBLE WITH	INPUT VOLTAGE	ORDERING NUMBER
SENSOR FOR LED HIGH BAY V3	LED HIGH BAY V3	12V	HB-MS-V3 
			HB-PIR-V3 

HB-100W-40K-R-V3

Flux out:10640 lm

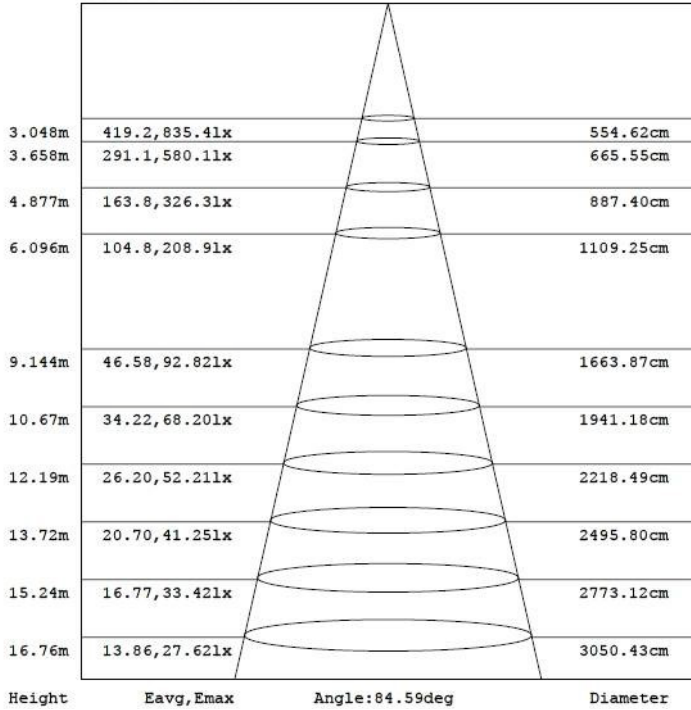

LUMINOUS INTENSITY DISTRIBUTION DIAGRAM

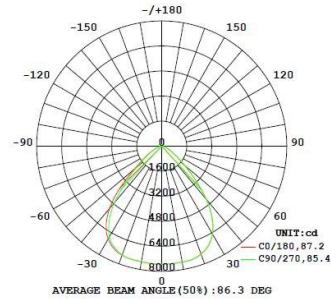

Zonal Lumen Summary

Zone	Lumens	% Lamp	% Luminaire
0-30	6,101.6	41.8%	41.8%
0-40	9,707.5	66.5%	66.6%
0-60	13,452.2	92.2%	92.2%
60-90	784.5	5.4%	5.4%
70-100	282.7	1.9%	1.9%
90-120	114.1	0.8%	0.8%
0-90	14,236.7	97.6%	97.6%
90-180	347.5	2.4%	2.4%
0-180	14,584.2	100%	100%

HB-100W-50K-R-V3

Flux out:10982 lm

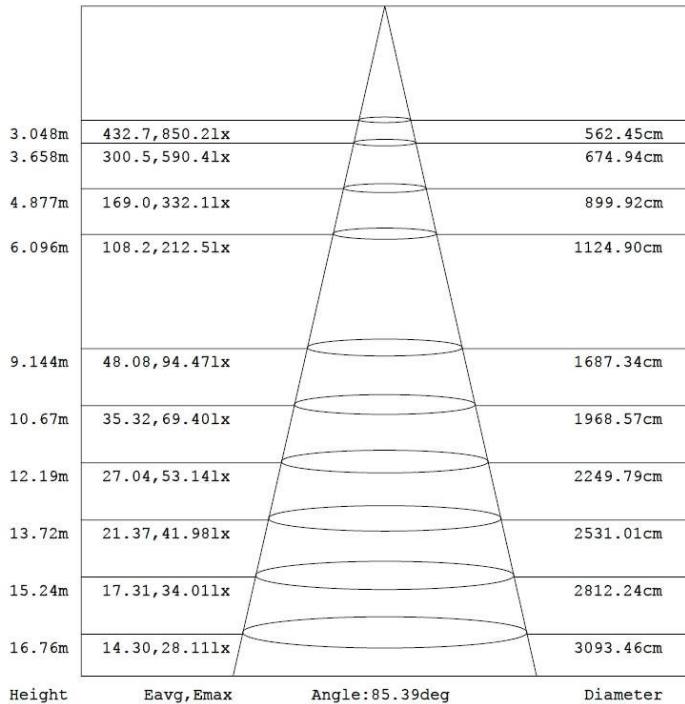

LUMINOUS INTENSITY DISTRIBUTION DIAGRAM

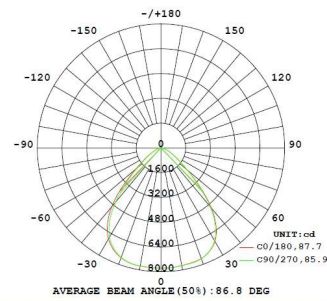

Zonal Lumen Summary

Zone	Lumens	% Lamp	% Luminaire
0-30	6,273.3	41.6%	41.6%
0-40	10,008.8	66.4%	66.4%
0-60	13,901.5	92.2%	92.2%
60-90	813.2	5.4%	5.4%
70-100	293.7	1.9%	1.9%
90-120	118.3	0.8%	0.8%
0-90	14,714.7	97.6%	97.6%
90-180	359.4	2.4%	2.4%
0-180	15,074.1	100%	100%



HB-150W-40K-R-V3

Flux out:15778 lm

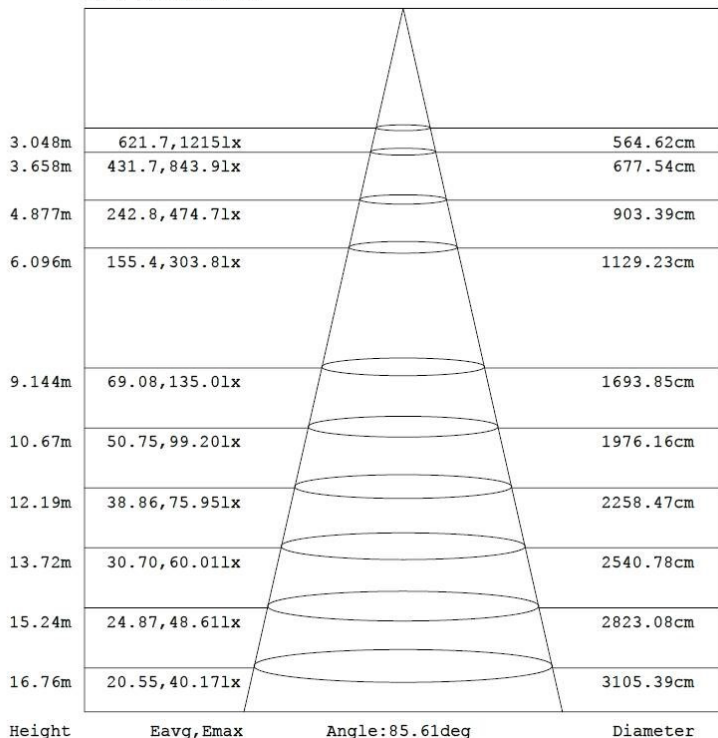

LUMINOUS INTENSITY DISTRIBUTION DIAGRAM

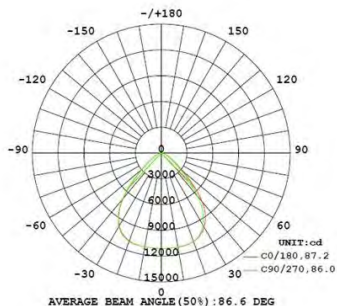

Zonal Lumen Summary

Zone	Lumens	% Lamp	% Luminaire
0-30	9,031.5	41.7%	41.7%
0-40	14,387.9	66.5%	66.5%
0-60	19,928.4	92.1%	92.1%
60-90	1,188.9	5.5%	5.5%
70-100	434.4	2%	2%
90-120	169.8	0.8%	0.8%
0-90	21,117.4	97.6%	97.6%
90-180	516.2	2.4%	2.4%
0-180	21,633.6	100%	100%

HB-150W-50K-R-V3

Flux out:15902 lm

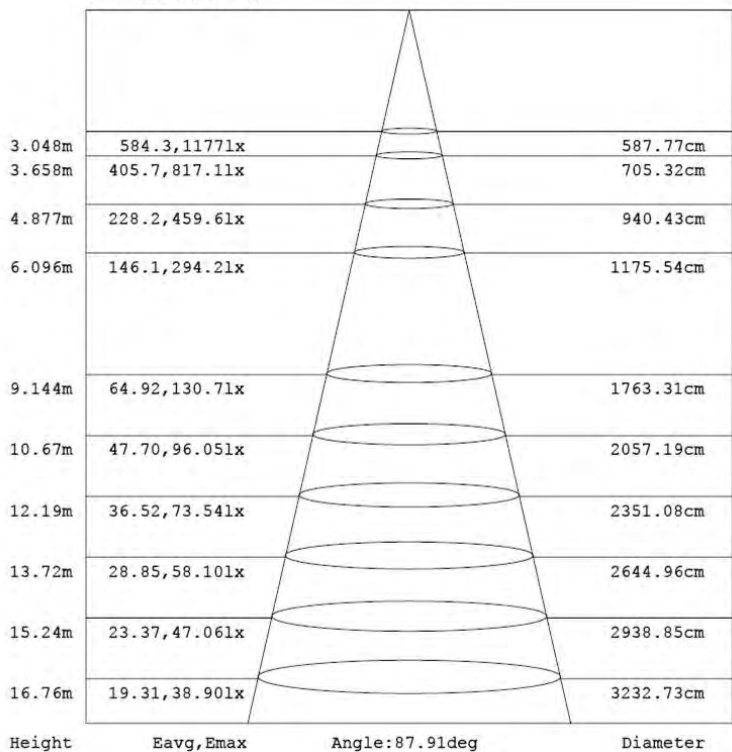

LUMINOUS INTENSITY DISTRIBUTION DIAGRAM

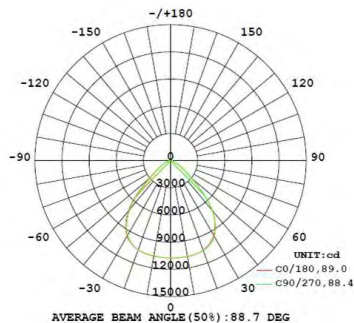

Zonal Lumen Summary

Zone	Lumens	% Lamp	% Luminaire
0-30	8,719.3	40.7%	40.7%
0-40	14,031.5	65.5%	65.5%
0-60	19,743.7	92.1%	92.1%
60-90	1,172.5	5.5%	5.5%
70-100	420.7	2%	2%
90-120	169.1	0.8%	0.8%
0-90	20,916.2	97.6%	97.6%
90-180	510.0	2.4%	2.4%
0-180	21,426.2	100%	100%



HB-200W-40K-R-V3



Flux out:21397 lm

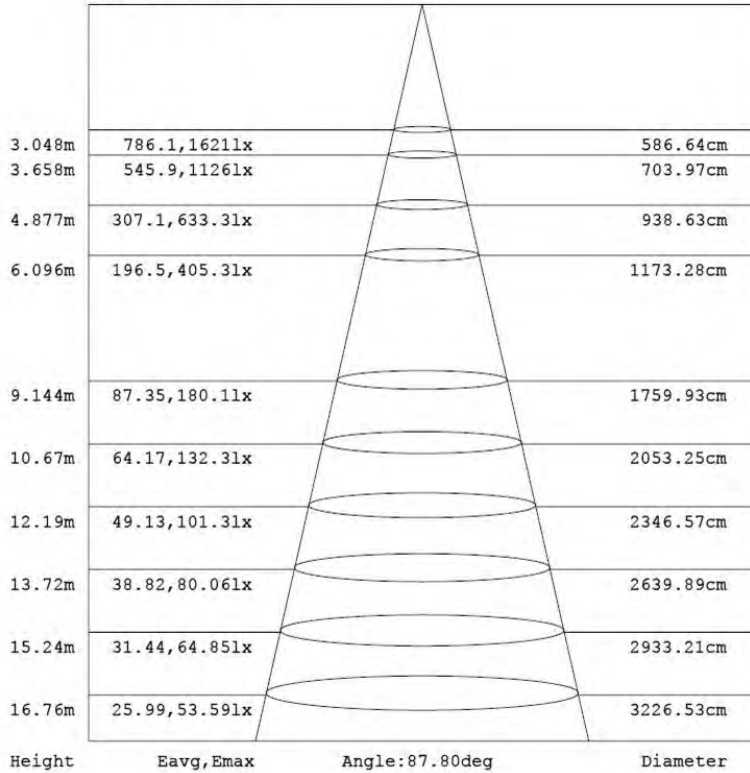

LUMINOUS INTENSITY DISTRIBUTION DIAGRAM

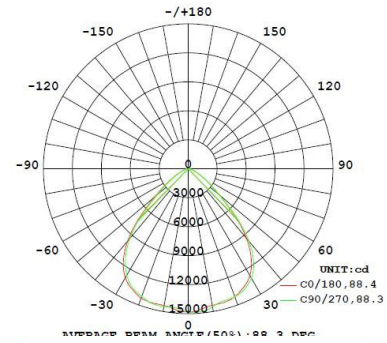

Zonal Lumen Summary			
Zone	Lumens	% Lamp	% Luminaire
0-30	11,730.5	40.6%	40.6%
0-40	18,882.2	65.3%	65.3%
0-60	26,645.7	92.1%	92.1%
60-90	1,587.6	5.5%	5.5%
70-100	560.1	1.9%	1.9%
90-120	229.3	0.8%	0.8%
0-90	28,233.3	97.6%	97.6%
90-180	687.5	2.4%	2.4%
0-180	28,920.8	100%	100%

HB-200W-50K-R-V3

Flux out:21728 lm

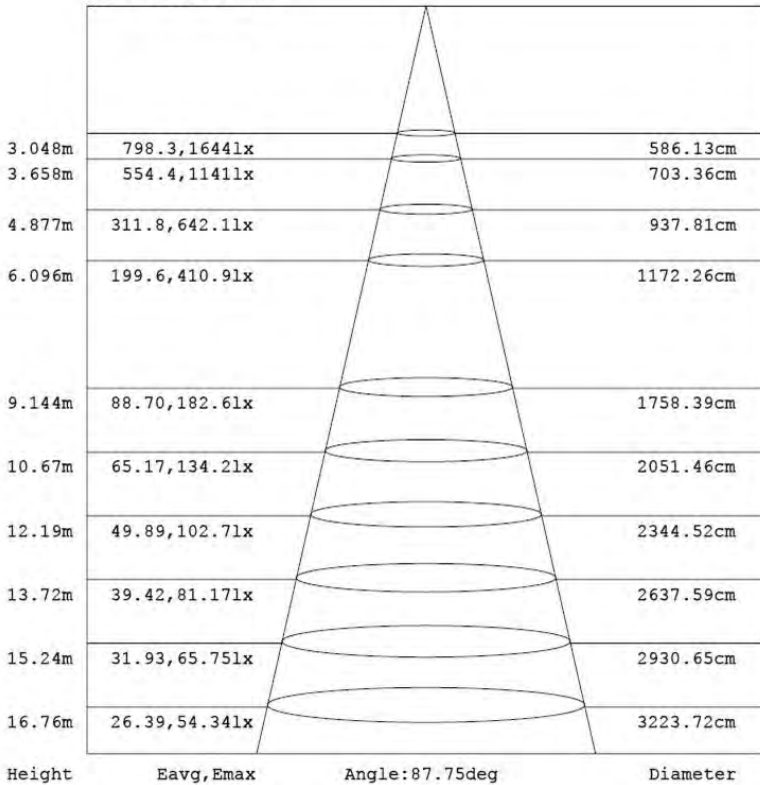

LUMINOUS INTENSITY DISTRIBUTION DIAGRAM

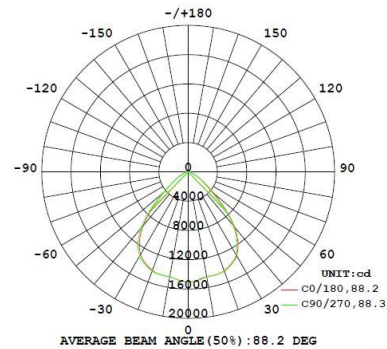

Zonal Lumen Summary			
Zone	Lumens	% Lamp	% Luminaire
0-30	11,908.0	40.6%	40.6%
0-40	19,182.3	65.4%	65.4%
0-60	26,998.7	92%	92.1%
60-90	1,623.7	5.5%	5.5%
70-100	579.9	2%	2%
90-120	239.0	0.8%	0.8%
0-90	28,622.4	97.6%	97.6%
90-180	707.5	2.4%	2.4%
0-180	29,329.9	100%	100%

HB-240W-50K-R-V3

Flux out: 25610 lm

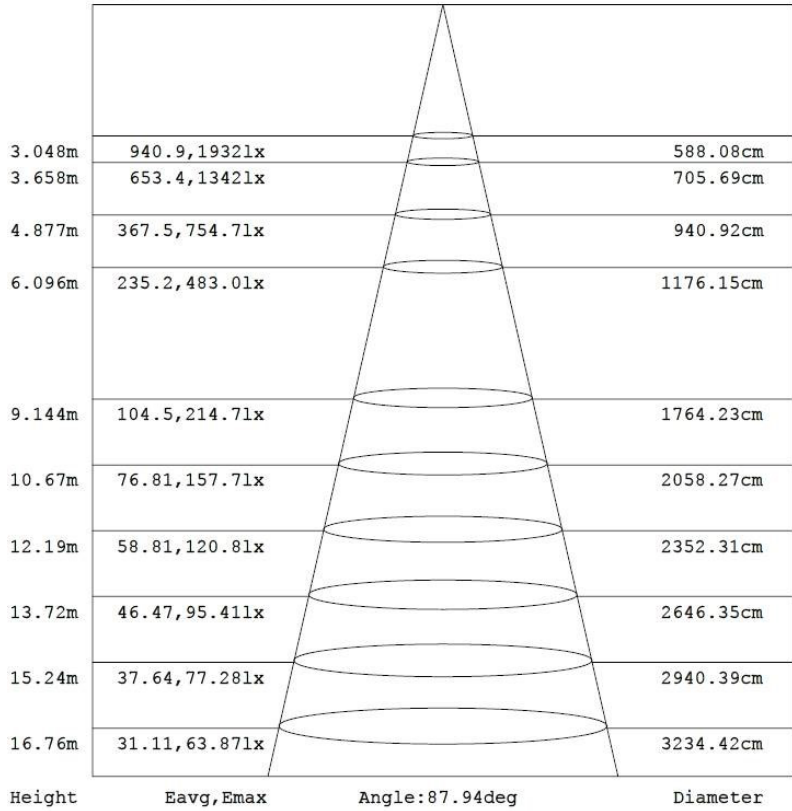

LUMINOUS INTENSITY DISTRIBUTION DIAGRAM

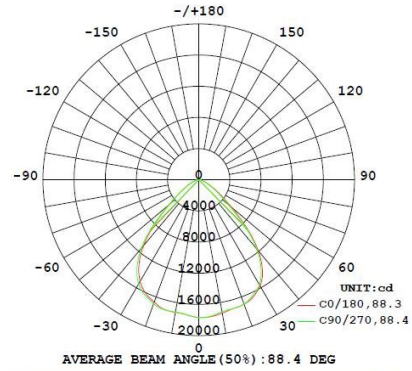

Zonal Lumen Summary

Zone	Lumens	% Lamp	% Luminaire
0-30	14,032.5	40.5%	40.5%
0-40	22,598.6	65.3%	65.3%
0-60	31,868.6	92.1%	92.1%
60-90	1,915.0	5.5%	5.5%
70-100	676.6	2%	2%
90-120	275.2	0.8%	0.8%
0-90	33,783.6	97.6%	97.6%
90-180	823.8	2.4%	2.4%
0-180	34,607.4	100%	100%

* Data is based on tests performed in a controlled environment. Actual performance can vary depending on operating conditions. All products are subject to change or may be discontinued at any time without notice.
 Colour temperature and Lumen output are changeable up to 5%.



GET YOUR PRODUCTS FAST
Arani is committed to same day shipping on orders before 3pm*.



LED High Bay

NOTABLE ARANI

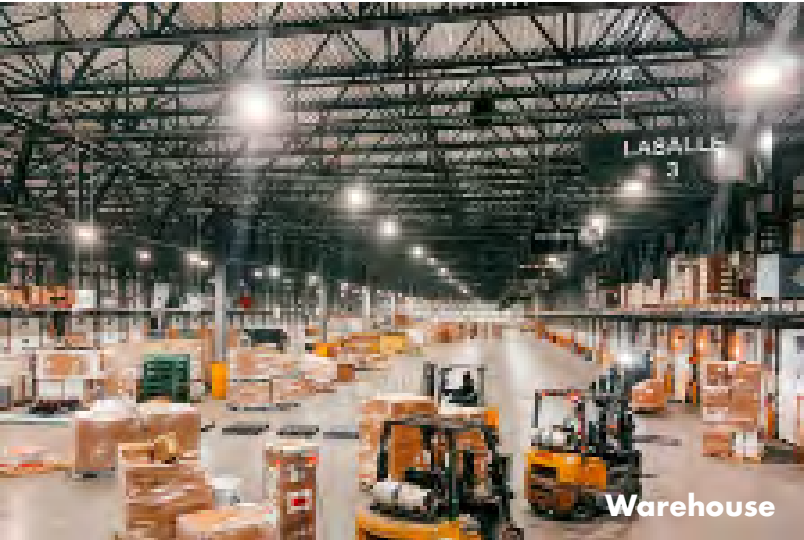

Warehouse



Showroom at Elegance Leasing

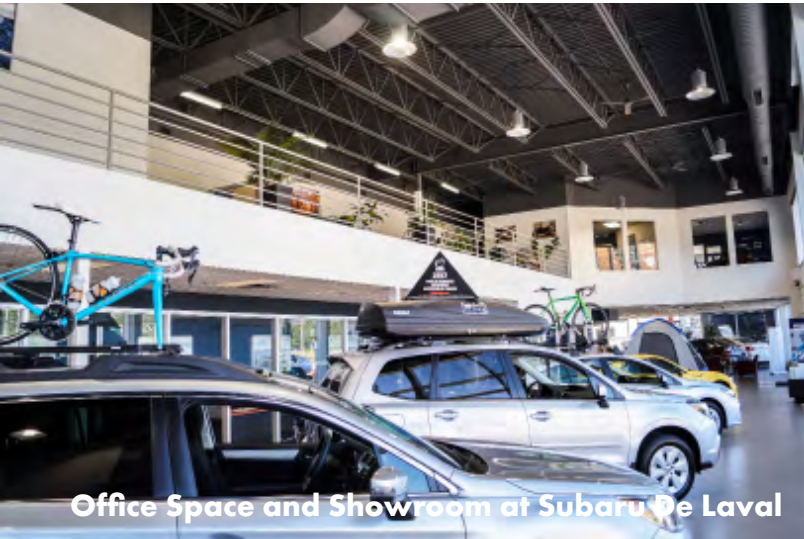

Office Space and Showroom at Subaru De Laval



Store Interior at Emery Centre Jardin



Curling Rink in Virден, Manitoba



Barn at Blackbay Farm

