



# ARANI

LED LIGHTING  
CATALOG



WINTER 2019



# A Word from the President



**Sean Arani**  
**Founder & President**

“The customer. At Arani we believe in making the lives of our customers as easy as possible and the use of environmentally friendly products affordable. We are not in business. We have a purpose, and we do our best to serve that purpose. We believe in creating partnerships that will last generations, not months or years. Our job is to learn the problems our customers live and solve them. Our company meetings do not revolve around “How can we sell more?”, instead we ask ourselves “How can we become better partners of our customers?” With that in mind, we spend much of our time and money on research and development to offer innovative products to the market, and to be knowledgeable specialists in our field.

Our LED lighting products are designed to be of the highest quality at the lowest prices possible. They are backed by our no-questions-asked warranty. I am thankful for your support of our purpose through this journey, and look forward to shaping a long term partnership with you.”



# OUR LED PRODUCTS

 **GET YOUR PRODUCTS FAST**  
Arani is committed to same day shipping on orders placed before 3pm (EST)\*.

RESIDENTIAL

	<b>TUNABLE WHITE/GIMBAL LED POT LIGHTS</b>	5
--	--	---

	<b>DOMED LED CEILING LIGHT</b>	9
--	--------------------------------	---

	<b>DECORATIVE LED WALL SCONCES</b>	11
--	------------------------------------	----

	<b>DECORATIVE LED UP &amp; DOWN LIGHT</b>	13
--	---	----

	<b>OVIVO &amp; ALTUM LED LINEAR LIGHTS</b>	15
--	--	----

	<b>INDOOR/WEATHERPROOF LED STRIPS &amp; EXTRUSIONS</b>	18
--	--	----

	<b>LUNAR SIGNATURE RECESSED EXTRUSION</b>	23
--	---	----

	<b>DOT-FREE FLEXITUBE</b>	25
--	---------------------------	----

	<b>DRIVERLESS 120V LED STRIP</b>	27
--	----------------------------------	----

	<b>SIGN LIGHTING LED MODULES</b>	29
--	----------------------------------	----

	<b>TUNABLE WHITE LED PANELS</b>	31
--	---------------------------------	----

	<b>TUNABLE WHITE LED TROFFERS</b>	35
--	-----------------------------------	----

RESIDENTIAL

	<b>LED WRAPAROUND FIXTURE</b>	37
--	-------------------------------	----

	<b>HIGH LUMEN LED FLOOD LIGHTS</b>	39
---	------------------------------------	----

	<b>HYBRID LED SHOEBOX FLOOD LIGHT</b>	46
---	---------------------------------------	----

	<b>SLIM PROFILE LED CANOPY LIGHT</b>	51
---	--------------------------------------	----

	<b>LED VAPOR TIGHT FIXTURE</b>	53
---	--------------------------------	----

	<b>SIGNATURE LED WALL PACKS WP2, WP7</b>	55
---	--	----

	<b>SIGNATURE LED WALL PACKS WP10, WP11</b>	56
---	--	----

	<b>WATERPROOF LED WALL WASHER</b>	59
--	-----------------------------------	----

	<b>LED HIGH BAYS</b>	61
---	----------------------	----

	<b>T5 / T8 LED TUBES</b>	65
---	--------------------------	----

	<b>SIGNATURE LED LAMPS FILAMENT, PAR16, PAR20, PAR30-SN, PAR30, PAR38</b>	69
---	---	----

	<b>SIGNATURE LED LAMPS G4, G9, MR11, MR16, GU10, A19</b>	72
---	--	----

	<b>LED ACCESSORIES TRANSFORMERS, RGB CONTROLLER, RGB AMPLIFIER</b>	75
---	--	----

	<b>ELECTRICAL DEVICES &amp; HARDWARE STEP DOWN DRIVERS, ELECTRICAL BOXES, COVERS</b>	79
---	--	----

COMMERCIAL

INDUSTRIAL

 \*Applies for products in the catalog with this icon only. For latest stock information, please consult [arani.ca](http://arani.ca).



# LED POT LIGHTS VERSION 2

## TUNABLE WHITE LED SLIM PANEL



4" Slim Panel (White)  
SL4-VAR-R-WH-V2

4" Slim Panel (Black)  
SL4-VAR-R-BK-V2

6" Slim Panel (Brushed Nickel)  
SL6-VAR-R-BN-V2

**5** years Limited Warranty

Lifetime 35 000 hours

IP40 Suitable for use in damp locations

3000K  
5000K  
4000K  
Toggle Switch CCT Variable

Triac Dimmable

ETL LISTED

**FEATURES**  
Robust Aluminium Casing & Trim  
Exceptionally Slim Profile  
High Quality Mounting Springs  
Input Voltage: 110-130V AC  
Color Rendering Index: >80  
Operating Temperature: -20°C to 40°C  
Easily adjust colour temperature with toggle switch

SERIES	POWER (WATTS)	EQUIVALENT TO (WATTS)	LUMENS	COLOR TEMPERATURE	TRIM COLOR	MODEL NUMBER
4" TUNABLE WHITE (TOGGLE SWITCH) SLIM PANEL	10W	60W	3000K: 589 4000K: 704 5000K: 673	CCT VARIABLE 3000K 4000K 5000K	WHITE	SL4-VAR-R-WH-V2
					BRUSHED NICKEL	SL4-VAR-R-BN-V2
					BLACK	SL4-VAR-R-BK-V2
6" TUNABLE WHITE (TOGGLE SWITCH) SLIM PANEL	15W	100W	3000K: 950 4000K: 1050 5000K: 980	CCT VARIABLE 3000K 4000K 5000K	WHITE	SL6-VAR-R-WH-V2
					BRUSHED NICKEL	SL6-VAR-R-BN-V2
					BLACK	SL6-VAR-R-BK-V2

Products with this icon are in stock, and ship out on the same day when ordered before 3pm (EST). For latest stock information, please consult [arani.ca](http://arani.ca).

Toll Free: (888) 992-7264 | [arani.ca](http://arani.ca)

## GIMBAL SLIM LED POT LIGHT

6

Gimbal  
Pot LightGimbal Engine (White)  
SLG-xxK-R-WH-V25  
years  
Limited  
WarrantyLifetime  
35 000 hoursIP40  
Suitable for use in  
damp locationsTriac  
DimmableETL  
US

## FEATURES

Adjustable Gimbal Head  
Robust Aluminum Body  
High Quality Mounting Springs  
Input Voltage: 110-130V AC  
Color Rendering Index: >80  
Operating Temperature: -20°C to 40°C

Trim Required and Sold Separately (See Page 7)

SERIES	POWER (WATTS)	EQUIVALENT TO (WATTS)	LUMENS	COLOR TEMPERATURE	HEAD COLOR	MODEL NUMBER
GIMBAL SLIM POT LIGHT ENGINE	8W	60W	730	3000K	WHITE	SLG-30K-R-WH-V2
					BLACK	SLG-30K-R-BK-V2
					BRUSHED NICKEL	SLG-30K-R-BN-V2
				4000K	WHITE	SLG-40K-R-WH-V2
					BLACK	SLG-40K-R-BK-V2
					BRUSHED NICKEL	SLG-40K-R-BN-V2



Products with this icon are in stock, and ship out on the same day when ordered before 3pm (EST). For latest stock information, please consult [arani.ca](http://arani.ca).

Toll Free: (888) 992-7264 | [arani.ca](http://arani.ca)

## GIMBAL SLIM LED POT LIGHT

7

Gimbal  
Pot Light3" Gimbal Trim (White)  
with White Gimbal Engine  
SL3G-TR-WH-V2 + SLG-xxK-R-WH-V24" Gimbal Trim (White)  
with White Gimbal Engine  
SL4G-TR-WH-V2 + SLG-xxK-R-WH-V2

Requires Gimbal Pot Light Engine (See Page 6)

## FEATURES

Easy Installation (Insert & Twist)  
Robust Aluminum Trim

SERIES	OPENING SIZE	DIMENSIONS	TRIM COLOR	MODEL NUMBER
3" GIMBAL SLIM POT LIGHT TRIM	Ø 3"	Ø 3 1/2"	WHITE	SL3G-TR-WH-V2
			BLACK	SL3G-TR-BK-V2
			BRUSHED NICKEL	SL3G-TR-BN-V2
4" GIMBAL SLIM POT LIGHT TRIM	Ø 4"	Ø 4 3/4"	WHITE	SL4G-TR-WH-V2
			BLACK	SL4G-TR-BK-V2
			BRUSHED NICKEL	SL4G-TR-BN-V2



Products with this icon are in stock, and ship out on the same day when ordered before 3pm (EST). For latest stock information, please consult [arani.ca](http://arani.ca).

Toll Free: (888) 992-7264 | [arani.ca](http://arani.ca)

# LED CEILING LIGHT VERSION 2

8

## DOMED LED CEILING LIGHT

9

  
Ceiling  
Light

Ceiling Light  
CE-30K-V2



5  
years  
Limited  
Warranty



Lifetime  
50 000 hours



IP54  
Suitable for use in  
damp locations



Triac  
Dimmable



ETL  
US  
LISTED

### FEATURES

- Acrylic Dome Diffuser
- Robust Aluminium Casing
- Color Rendering Index: >80
- Operating Temperature: -15°C to 40°C
- Input Voltage: 110VAC

SERIES	POWER (WATTS)	EQUIVALENT TO (WATTS)	LUMENS	COLOR TEMP	INPUT VOLTAGE	MODEL NUMBER
CEILING LIGHT VERSION 2	14	100	1143	3000K	110VAC	CE-30K-V2 

 Products with this icon are in stock, and ship out on the same day when ordered before 3pm (EST). For latest stock information, please consult [arani.ca](http://arani.ca).

Toll Free: (888) 992-7264 | [arani.ca](http://arani.ca)



# LED WALL SCONCES ROUND / FLAT

## DECORATIVE LED WALL SCONCES



### FEATURES

- Robust Aluminium Casing
- Color Rendering Index: >80
- Operating Temperature: -30°C to 45°C
- Input Voltage: 100 - 240V AC

SERIES	POWER (WATTS)	EQUIVALENT TO (WATTS)	LUMENS	COLOR TEMP	PHOTOCELL/ MOTION SENSING TECHNOLOGY	MODEL NUMBER
ROUND WALL SCONCE	10	60	680	3000K	YES	SC2-R
FLAT WALL SCONCE	10	60	680	3000K	NO	SC1-F

Products with this icon are in stock, and ship out on the same day when ordered before 3pm (EST). For latest stock information, please consult [arani.ca](http://arani.ca).



# LED UP & DOWN LIGHT VERSION 2

## DECORATIVE LED UP & DOWN LIGHT

## Up & Down Light



### FEATURES

- Robust Aluminium Casing (Black)
- Color Rendering Index: >80
- Operating Temperature: -40°C to 50°C
- Input Voltage: 100 - 277V AC

SERIES	DIAMETER	POWER (WATTS)	EQUIVALENT TO (WATTS)	LUMENS	COLOR TEMP	MODEL NUMBER
UP & DOWN LIGHT V2	4"	2 X 10	50	2 x 900	3000K	UD-RD-20W-30K-V2
					4000K	UD-RD-20W-40K-V2
	6"	2 X 25	120	2 x 2250	4000K	UD-RD-50W-40K-V2

Products with this icon are in stock, and ship out on the same day when ordered before 3pm (EST). For latest stock information, please consult [arani.ca](http://arani.ca).

Toll Free: (888) 992-7264 | [arani.ca](http://arani.ca)





# LED LINEAR LIGHTING

14

## ALTUM LED LINEAR LIGHT

15

Linear  
Lighting

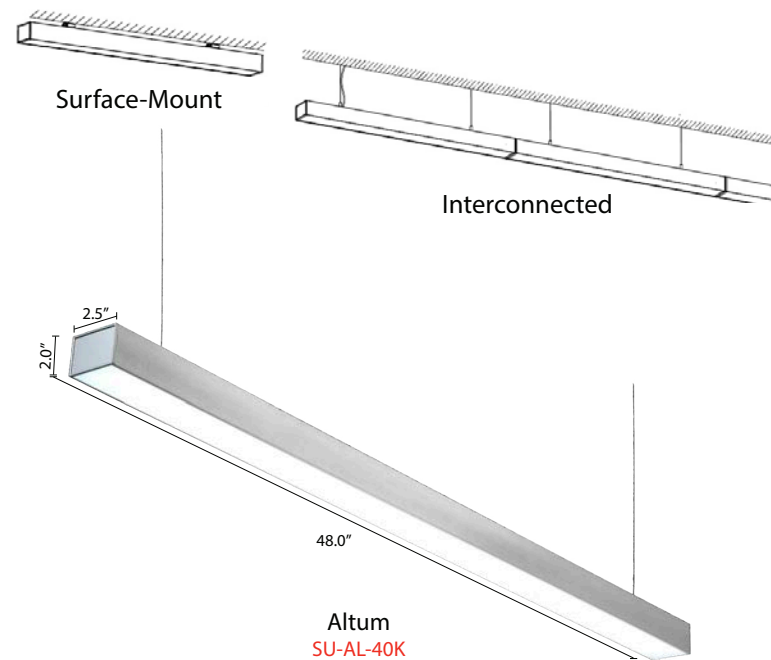

5  
years  
Limited  
Warranty

Lifetime  
50 000 hours

IP40  
Suitable for use in  
damp locations

0-10V  
Dimmable



### FEATURES

- Interconnected Installation Possible
- Robust Aluminium Casing
- Exceptionally Slim Profile
- Beam Angle: 120°
- Color Rendering Index: >83
- Input Voltage: 110-260V
- Operating Temperature: 0°C to 40°C
- Surface-Mount / Suspension Mount

SERIES	POWER (WATTS)	EQUIVALENT TO (WATTS)	LUMENS	COLOR TEMPERATURE	MODEL NUMBER
ALTUM LINEAR LIGHT	40	150	3200	4000K	SU-AL-40K 

 Products with this icon are in stock, and ship out on the same day when ordered before 3pm (EST). For latest stock information, please consult [arani.ca](http://arani.ca).

Toll Free: (888) 992-7264 | [arani.ca](http://arani.ca)

## OVIO LED LINEAR LIGHT

16

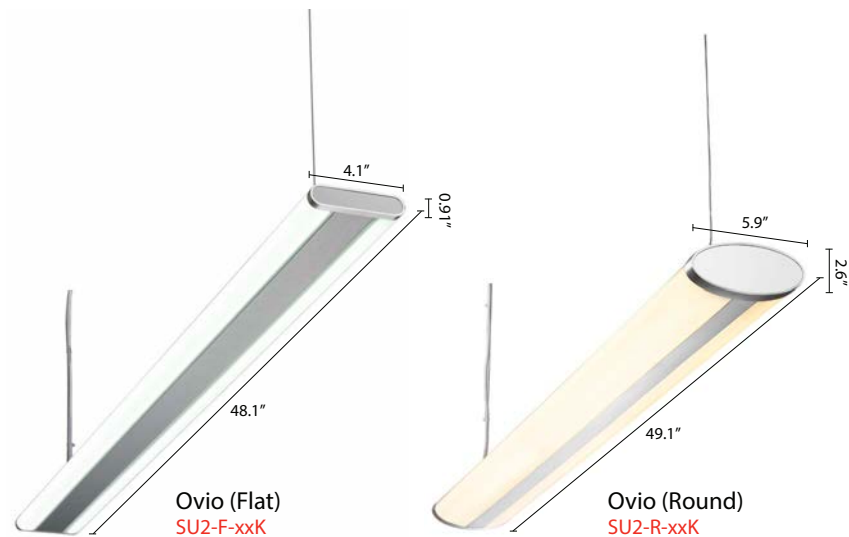
Linear  
Lighting5  
years  
Limited  
WarrantyLifetime  
50 000 hoursIP40  
Suitable for use in  
damp locationsETL  
US

## FEATURES

- Robust Aluminium Casing
- Exceptionally Slim Profile
- Color Rendering Index: >83
- Input Voltage: 110-260V
- Operating Temperature: 0°C to 40°C
- Suspension Mount

SERIES	POWER (WATTS)	EQUIVALENT TO (WATTS)	LUMENS	COLOR TEMPERATURE	MODEL NUMBER
OVIO LINEAR LIGHT (FLAT)	28.8	150	3200	3000K	SU2-F-30K
				4000K	SU2-F-40K
OVIO LINEAR LIGHT (ROUND)	28.8	150	3200	3000K	SU2-R-30K
				4000K	SU2-R-40K



Products with this icon are in stock, and ship out on the same day when ordered before 3pm (EST). For latest stock information, please consult [arani.ca](http://arani.ca).

Toll Free: (888) 992-7264 | [arani.ca](http://arani.ca)LED STRIPS  
& EXTRUSIONS

## INDOOR LED STRIPS

18

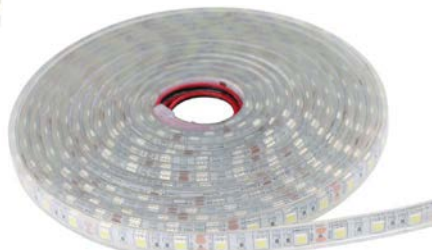

LED Strips &amp; Extrusions

Indoor LED Strip  
ST-xxW-xxK-IIP20  
Suitable for use in  
dry locationsWeatherproof LED Strip  
STxxxx-xxW-xx3  
years  
Limited  
WarrantyLifetime  
25 000 hoursLow Voltage  
Magnetic Dimmer  
DimmableLISTED  
E488407

## FEATURES

3M Peel Off Adhesive Tape for Easy Installation  
5 Meters (16.4ft) per Roll  
Color Rendering Index: >90  
Operating Temperature: -10°C to 40°C  
Max Length per Run: 10 Meters (~32ft)  
Custom Sizes by the Inch Available (See Page 87)

SERIES	INPUT VOLTAGE	POWER (WATTS)	POWER/FT (WATTS)	LUMENS /FT	LED QTY (SMD)	WIDTH	MIN. CUT DISTANCE	COLOR TEMP	MODEL NUMBER
24W INDOOR STRIP	12VDC	24	1.5	150	300 x 3528	0.47"	50mm	3000K	ST-24W-30K-I
								6000K	ST-24W-60K-I
72W INDOOR STRIP	12VDC	72	4.5	400	300 x 5050	0.47"	50mm	3000K	ST-72W-30K-I
								4000K	ST-72W-40K-I
								6000K	ST-72W-60K-I
120W INDOOR STRIP	24VDC	120	7.5	500	1200 x 3014	0.47"	25mm	3000K	ST-120W-30K-I
								6000K	ST-120W-60K-I



Products with this icon are in stock, and ship out on the same day when ordered before 3pm (EST). For latest stock information, please consult [arani.ca](http://arani.ca).

Toll Free: (888) 992-7264 | [arani.ca](http://arani.ca)

## WEATHERPROOF LED STRIPS

19



LED Strips &amp; Extrusions

IP67  
Suitable for use in  
wet locations

SERIES	INPUT VOLTAGE	POWER (WATTS)	POWER/FT (WATTS)	LUMENS /FT	LED QTY (SMD)	WIDTH	MIN. CUT DISTANCE	COLOR TEMP	MODEL NUMBER
24W WEATHERPROOF STRIP	12VDC	24	1.5	150	300 x 3528	0.31"	50mm	3000K	ST3528-24W-WW
								6000K	ST3528-24W-CW
								RED	ST3528-24W-R
								GREEN	ST3528-24W-G
36W WEATHERPROOF STRIP	12VDC	36	2.25	230	150 x 5050	0.47"	105mm	3000K	ST5050-36W-WW
								6000K	ST5050-36W-CW
								RGB	ST5050-36W-RGB
								BLUE	ST5050-36W-B
48W WEATHERPROOF STRIP	12VDC	48	3	330	600 x 3528	0.31"	25mm	3000K	ST3528-48W-WW
								6000K	ST3528-48W-CW
								RED	ST3528-48W-R
								GREEN	ST3528-48W-G
								BLUE	ST3528-48W-B
72W WEATHERPROOF STRIP	12VDC	72	4.5	400	300 x 5050	0.47"	50mm	3000K	ST5050-72W-WW
								4000K	ST5050-72W-40K
								6000K	ST5050-72W-CW
								RGBW	ST5050-72W-RGBW

## LED STRIP ACCESSORIES



ARANI's revolutionary grip-on connectors serve as an efficient alternative to soldering. Soldering is still recommended for a stronger connection.

SERIES	COMPATIBLE WITH	CONNECTOR TYPE	APPLICATION	MODEL NUMBER
3528 STRIP CONNECTORS	ST3528 LED STRIPS ST-24W-xxK-I STRIPS	2 WIRES	STRIP TO WIRE	ST-C-2-3528
		NO WIRES	STRIP TO STRIP	ST-C-N-3528
		L SHAPE	STRIP TO STRIP (CORNERS)	C-L-3528
5050 STRIP CONNECTORS	ST5050 LED STRIPS ST-72W-xxK-I STRIPS	2 WIRES	STRIP TO WIRE	ST-C-2-5050
		NO WIRES	STRIP TO STRIP	ST-C-N-5050
		L SHAPE	STRIP TO STRIP (CORNERS)	C-L-5050
RGB STRIP CONNECTORS	RGB LED STRIPS	4 WIRES	STRIP TO WIRE	ST-C-4
		NO WIRES	STRIP TO STRIP	ST-C-N-RGB
		L SHAPE	STRIP TO STRIP (CORNERS)	C-L-RGB
LED STRIP END CAP	ALL STRIPS	END CAP	SEALING STRIP END	ST-EC-C
LED STRIP INSTALLATION BRACKET	ALL STRIPS	BRACKET	SECURING STRIPS	AC-ST-IB
INSTALLATION KITS	ST3528 LED STRIPS ST-24W-xxK-I STRIPS	10 INSTALLATION BRACKETS, 2 CONNECTORS (3528   2 WIRES), 4 END CAPS, 1 SILICA GEL		ST-C-3528-KIT
	ST5050 LED STRIPS ST-72W-xxK-I STRIPS	10 INSTALLATION BRACKETS, 2 CONNECTORS (5050   2 WIRES), 4 END CAPS, 1 SILICA GEL		ST-C-5050-KIT

20



LED Strips &amp; Extrusions

## ALUMINIUM EXTRUSIONS

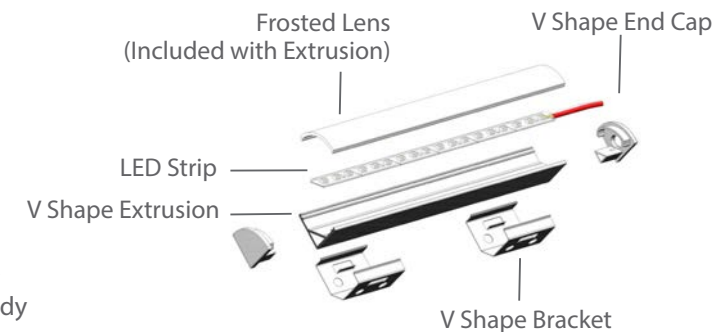

## FEATURES

Snap-On Frosted Lens  
Robust Aluminium Body  
Surface-Mount Brackets Available  
Custom Sizes by the Inch Available (See Page 87)

SERIES	COMPATIBLE WITH	MODEL NUMBER
SQUARE EXTRUSION (BY INCH)	ALL STRIPS	PR-S-V1-IN
V SHAPE EXTRUSION (BY INCH)	ALL STRIPS	PR-V-V1-IN
SQUARE END CAP (CLOSED)	SQUARE EXTRUSION	C-PR-EC-S-CL-V1
SQUARE END CAP (OPEN)	SQUARE EXTRUSION	C-PR-EC-S-O-V1
V SHAPE END CAP (CLOSED)	V SHAPE EXTRUSION	C-PR-EC-V-CL-V1
V SHAPE END CAP (OPEN)	V SHAPE EXTRUSION	C-PR-EC-V-O-V1
SQUARE BRACKETS	SQUARE EXTRUSION	C-PR-BR-S-V1
V SHAPE BRACKETS	V SHAPE EXTRUSION	C-PR-BR-V-V1



Products with this icon are in stock, and ship out on the same day when ordered before 3pm (EST). For latest stock information, please consult [arani.ca](http://arani.ca).



21



LED Strips &amp; Extrusions

# LUNAR SIGNATURE RECESSED EXTRUSION

## LUNAR SIGNATURE RECESSED EXTRUSION

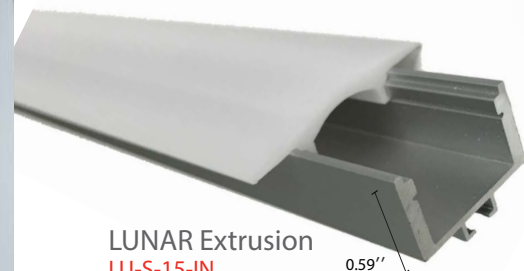

LUNAR Extrusion  
LU-S-15-IN

0.59"

LUNAR Lock System



Gyproc/  
Drywall

LUNAR



Watch our LUNAR Highlight Video  
on our website!

### FEATURES

- Fully Recesses into Gyproc/Drywall
- Easy Snap-In Installation with Springs
- Snap-On Frosted Lens
- Robust Aluminium Body

Custom Sizes by the Inch Available (See Page 87)

Recommended for use with 120W LED Strips (see Page 18) for a linear, dot-free look

SERIES	COMPATIBLE WITH	MODEL NUMBER
LUNAR EXTRUSION	ALL STRIPS	LU-S-15-IN 
LUNAR SPRING	LUNAR EXTRUSION	LU-S-15-SP 



Products with this icon are in stock, and ship out on the same day when ordered before 3pm (EST). For latest stock information, please consult [arani.ca](http://arani.ca).

Toll Free: (888) 992-7264 | [arani.ca](http://arani.ca)

# UNIFORM LIGHTING FLEXITUBE

24

## UNIFORM LIGHTING FLEXITUBE

25

LED Strips &amp; Extrusions

**Flexitube**  
FT-15W-xxK

Uniform Light Output  
(No Spots)

**Surface-Mount Brackets**  
FT-BR

3M Adhesive Back

**2 years**  
Limited Warranty

Lifetime  
25 000 hours

IP65  
Suitable for use in wet locations

Dimmable

UL LISTED  
E338485

**FEATURES**  
Uniform Light Output (No Spots)  
3M Peel Off Adhesive Tape for Easy Installation  
Flexible Silicone Finish  
Color Rendering Index: >80  
Operating Temperature: -50°C to 40°C  
Max Length per Run: 32FT  
Only Available By Inch (See Page 87)  
**Shipping Speed May Vary Based on Order Size**

SERIES	INPUT VOLTAGE	MIN. CUT DISTANCE	POWER/FT (WATTS)	LUMENS/FT	WIDTH	COLOR TEMP	MODEL NUMBER
FLEXITUBE	24VDC	1.5"	5	425	0.43" (11mm)	3000K	FT-05W-30K-IN
						4000K	FT-05W-40K-IN
				160	0.59" (15mm)	RGB	FT-05W-RGB-IN

Products with this icon are in stock, and ship out on the same day when ordered before 3pm (EST). For latest stock information, please consult [arani.ca](http://arani.ca).

Toll Free: (888) 992-7264 | [arani.ca](http://arani.ca)

# DRIVERLESS 120V LED STRIP

26

## DRIVERLESS 120V LED STRIP

27

LED Strips &amp; Extrusions

**2**  
years  
Limited  
Warranty

**L**  
Lifetime  
25 000 hours

**IP65**  
Suitable for use in  
wet locations



**UL** US  
LISTED  
E338485





### FEATURES

Input Voltage: 120VAC  
3M Peel Off Adhesive Tape for Easy Installation  
45.7 Meters (150ft) per Roll  
Color Rendering Index: >80  
Operating Temperature: -10°C to 40°C  
Max Length per Run: 150ft  
Custom Sizes by the Inch Available (See Page 87)



120V LED Strip  
ST-120V-3W-xxK

SERIES	INPUT VOLTAGE	WIDTH	POWER/FT (WATTS)	LUMENS/FT	MIN. CUT DISTANCE	COLOR TEMP	MODEL NUMBER
DRIVERLESS 120V LED STRIP	120VAC	0.60"	3	250	10mm	3000K	ST-120V-3W-30K 
						4000K	ST-120V-3W-40K 

ACCESSORIES	APPLICATION	MODEL NUMBER
120V LED STRIP CONNECTORS	STRIP TO STRIP	ST-C-120V-CL 
120V LED STRIP 4FT POWER CORD (AC PLUG)	STRIP TO POWER	ST-C-120V-WI 
120V LED STRIP END CAP	SEALING STRIP END	ST-C-120V-EC 
120V LED STRIP BRACKET	SECURING STRIPS	ST-C-120V-BR 

 Products with this icon are in stock, and ship out on the same day when ordered before 3pm (EST). For latest stock information, please consult [arani.ca](http://arani.ca).

Toll Free: (888) 992-7264 | [arani.ca](http://arani.ca)

# SIGN LIGHTING LED MODULES VERSION 2

## SIGN LIGHTING LED MODULES



Modules (3 LED) V2  
MD3-50K-V2



3  
years  
Limited  
Warranty



Lifetime  
35 000 hours



IP68  
Suitable for use in  
wet locations



Dimmable



ETL  
US

### FEATURES

Daisy Chain Mounting

Input Voltage: 12V DC

Beam Angle: 160°

Color Rendering Index: >80

Operating Temperature: -40°C to 40°C

For best results, install 3 units per square foot

SERIES	POWER (WATTS)	LUMENS	COLOR TEMPERATURE	MODEL NUMBER
LED MODULES V2	1.2	170	5000K	MD3-50K-V2



Products with this icon are in stock, and ship out on the same day when ordered before 3pm (EST). For latest stock information, please consult [arani.ca](http://arani.ca).

Toll Free: (888) 992-7264 | [arani.ca](http://arani.ca)



# TUNABLE WHITE LED PANELS VERSION 3



30

## TUNABLE WHITE LED PANELS

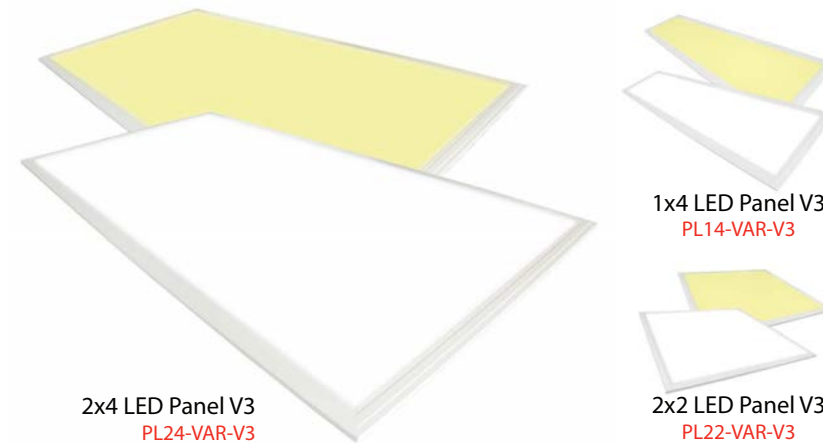

2x4 LED Panel V3  
PL24-VAR-V3

1x4 LED Panel V3  
PL14-VAR-V3

2x2 LED Panel V3  
PL22-VAR-V3

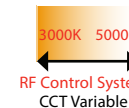

### FEATURES

Robust Aluminium Casing with White Trim

Color Rendering Index: >80

Operating Temperature: 0°C to 40°C

Compatible Suspension Kits and Surface-Mount Kits Available (See Page 33)

Easily adjust colour temperature and dimming with a wireless remote (See Page 32)

SERIES	POWER (WATTS)	EQUIVALENT TO (WATTS)	LUMENS	DIMENSIONS	COLOR TEMP	INPUT VOLTAGE	MODEL NUMBER
1 X 4 LED PANEL V3	40	2 X 30W T8	4400	12.00" x 48.00" x 2.00" (30.48cm x 121.92cm x 5.08cm)	CCT VARIABLE 3000K - 5000K	120-277VAC	PL14-VAR-V3
						347VAC	PL14-VAR-V3-347V
2 X 2 LED PANEL V3	40	2 X 30W T8	4400	24.00" x 24.00" x 2.00" (60.96cm x 60.96cm x 5.08cm)	CCT VARIABLE 3000K - 5000K	120-277VAC	PL22-VAR-V3
						347VAC	PL22-VAR-V3-347V
2 X 4 LED PANEL V3	50	2 X 32W T8	5500	24.00" x 48.00" x 2.00" (60.96cm x 121.92cm x 5.08cm)	CCT VARIABLE 3000K - 5000K	120-277VAC	PL24-VAR-V3
						347VAC	PL24-VAR-V3-347V



Products with this icon are in stock, and ship out on the same day when ordered before 3pm (EST). For latest stock information, please consult [arani.ca](http://arani.ca).

Toll Free: (888) 992-7264 | [arani.ca](http://arani.ca)

31

LED  
Panels

## RF CONTROL SYSTEM FOR TUNABLE WHITE LED PANELS

32

LED  
Panels

Wireless Remote  
**PL-V3-REMOTE**  
Controls up to 4 zones of lighting  
(Unlimited number of panels per zone)

**FEATURES**  
2.4GHz Radio Frequency Operated  
Easily adjust between colour temperatures :  
3000K - 3500K - 4000K - 5000K  
Dimmable with RF Control System (Wireless)  
Powered by Batteries  
Range : 100 Feet (~30 meters)

SERIES	COMPATIBLE WITH	BATTERIES	DIMENSIONS	MODEL NUMBER
WIRELESS REMOTE	TUNABLE WHITE LED PANELS V3	2 x AAA	5.80" x 1.75" x 0.75" (147.3mm x 44.5mm x 19.0mm)	PL-V3-REMOTE



Products with this icon are in stock, and ship out on the same day when ordered before 3pm (EST). For latest stock information, please consult [arani.ca](http://arani.ca).

Toll Free: (888) 992-7264 | [arani.ca](http://arani.ca)

## LED PANEL MOUNTING KITS

33

LED  
Panels

Surface-Mount Kit  
**PLxx-AC-M-V2**



Suspension Kit  
**PL-AC-S**

SERIES	DETAILS	COMPATIBLE WITH	MODEL NUMBER
SURFACE-MOUNT KIT (DIMMABLE LED PANELS)	SOME SIMPLE ASSEMBLY REQUIRED	1 X 4 LED PANELS	PL14-AC-M-V2
		2 X 2 LED PANELS	PL22-AC-M-V2
		2 X 4 LED PANELS	PL24-AC-M-V2
SUSPENSION KIT (DIMMABLE LED PANELS)	4 POINT SUSPENSION	ALL LED PANELS	PL-AC-S



Products with this icon are in stock, and ship out on the same day when ordered before 3pm (EST). For latest stock information, please consult [arani.ca](http://arani.ca).

Toll Free: (888) 992-7264 | [arani.ca](http://arani.ca)

# TUNABLE WHITE LED TROFFERS VERSION 3

34

## TUNABLE WHITE LED TROFFERS

35



2x2 LED Troffer V3  
TR22-VAR-V3



2x4 LED Troffer V3  
TR24-VAR-V3



5  
years  
Limited  
Warranty



Lifetime  
50 000 hours



IP54  
Suitable for use in  
damp locations



0-10V /  
RF Control System  
Dimmable

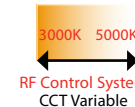

3000K 5000K  
RF Control System  
CCT Variable



UL US  
LISTED  
E480477



DLC  
LISTED

### FEATURES

Robust Aluminium Casing with White Trim  
Input Voltage: 120-277VAC  
Color Rendering Index: >80  
Operating Temperature: 0°C to 40°C

Easily adjust colour temperature and dimming with a wireless remote (See Page 32)

SERIES	POWER (WATTS)	EQUIVALENT TO (WATTS)	LUMENS	DIMENSIONS	COLOR TEMP	MODEL NUMBER
2 X 2 LED TROFFER V3	40	2 X 32W T8	4400	24.00" x 24.00" x 4.00" (60.96cm x 60.96cm x 10.16cm)	CCT VARIABLE 3000K - 5000K	TR22-VAR-V3
2 X 4 LED TROFFER V3	50	2 X 32W T8	5500	24.00" x 48.00" x 4.00" (60.96cm x 121.92cm x 10.16cm)	CCT VARIABLE 3000K - 5000K	TR24-VAR-V3



Products with this icon are in stock, and ship out on the same day when ordered before 3pm (EST). For latest stock information, please consult [arani.ca](http://arani.ca).

Toll Free: (888) 992-7264 | [arani.ca](http://arani.ca)



# LED WRAPAROUND FIXTURE VERSION 1

## LED WRAPAROUND FIXTURE

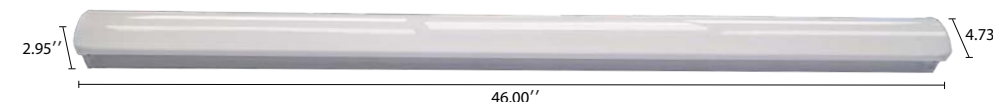

### FEATURES

- Knockouts on Both Sides and Back
- Suitable for Chain-Mounting in a Row
- Robust Aluminium Casing
- Color Rendering Index: >80
- Operating Temperature: -10°C to 40°C

SERIES	LENGTH	POWER (WATTS)	EQUIVALENT TO (WATTS)	LUMENS	COLOR TEMP	INPUT VOLTAGE	MODEL NUMBER
WRAPAROUND FIXTURE	2FT	25W	2 X 20W T8	3000	4000K	120-277VAC	WR-25W-40K-V1
					5000K	120-277VAC	WR-25W-50K-V1
	4FT	40W	2 X 32W T8	4800	4000K	120-277VAC	WR-40W-40K-V1
						347V	WR-40W-40K-V1-347V
					5000K	120-277VAC	WR-40W-50K-V1
						347V	WR-40W-50K-V1-347V

Products with this icon are in stock, and ship out on the same day when ordered before 3pm (EST). For latest stock information, please consult [arani.ca](http://arani.ca).

Toll Free: (888) 992-7264 | [arani.ca](http://arani.ca)



# HIGH LUMEN LED FLOOD LIGHTS

38

## HIGH LUMEN LED FLOOD LIGHTS

39

High Lumen  
Flood Lights

15W High Lumen Flood Light  
(Bracket)  
FL-15W-xxK-BR-V2

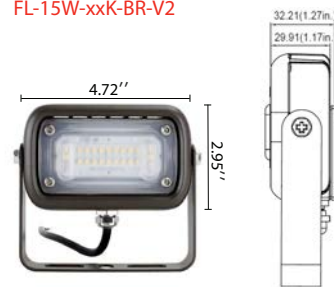

15W High Lumen Flood Light  
(Knuckle)  
FL-15W-xxK-KN-V2



### FEATURES

Exceptional Lumens/Watt

CREE LEDs

Robust Aluminium Casing

Color Rendering Index: >70

Operating Temperature: -40°C to 45°C

Input Voltage: 100-277VAC

Heatsink for Maximum Lifespan & Performance

SERIES	POWER (WATTS)	EQUIVALENT TO (WATTS)	LUMENS	BEAM ANGLE	MOUNT	COLOR	MODEL NUMBER
15W HIGH LUMEN FLOODLIGHT	15W	50W	1500	140°	BRACKET	3000K	FL-15W-30K-BR-V2
						4000K	FL-15W-40K-BR-V2
						5000K	FL-15W-50K-BR-V2
					KNUCKLE	3000K	FL-15W-30K-KN-V2
						4000K	FL-15W-40K-KN-V2
						5000K	FL-15W-50K-KN-V2



Products with this icon are in stock, and ship out on the same day when ordered before 3pm (EST). For latest stock information, please consult [arani.ca](http://arani.ca).

Toll Free: (888) 992-7264 | [arani.ca](http://arani.ca)

## HIGH LUMEN LED FLOOD LIGHTS

40

High Lumen  
Flood Lights45W High Lumen Flood Light  
(Bracket)  
FL-45W-xxK-BR-V245W High Lumen Flood Light  
(Knuckle)  
FL-45W-xxK-KN-V2

## FEATURES

- Exceptional Lumens/Watt
- CREE LEDs
- Robust Aluminium Casing
- Color Rendering Index: >70
- Operating Temperature: -40°C to 45°C
- Input Voltage: 100-277VAC
- Heatsink for Maximum Lifespan & Performance

SERIES	POWER (WATTS)	EQUIVALENT TO (WATTS)	LUMENS	BEAM ANGLE	MOUNT	COLOR	MODEL NUMBER
45W HIGH LUMEN FLOODLIGHT	45W	100W	5100	140°	BRACKET	3000K	FL-45W-30K-BR-V2
						4000K	FL-45W-40K-BR-V2
						5000K	FL-45W-50K-BR-V2
					KNUCKLE	3000K	FL-45W-30K-KN-V2
						4000K	FL-45W-40K-KN-V2
						5000K	FL-45W-50K-KN-V2



Products with this icon are in stock, and ship out on the same day when ordered before 3pm (EST). For latest stock information, please consult [arani.ca](http://arani.ca).

Toll Free: (888) 992-7264 | [arani.ca](http://arani.ca)

## HIGH LUMEN LED FLOOD LIGHTS

41

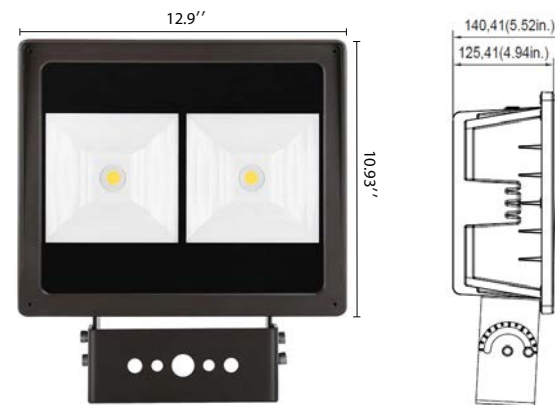
High Lumen  
Flood Lights110W High Lumen Flood Light  
(Bracket)  
FL-110W-xxK-V2

## FEATURES

- Exceptional Lumens/Watt
- CREE LEDs
- Robust Aluminium Casing
- Color Rendering Index: >70
- Operating Temperature: -40°C to 45°C
- Input Voltage: 100-277VAC
- Heatsink for Maximum Lifespan & Performance
- Compatible Slip Fitter Available (See Page 44)

SERIES	POWER (WATTS)	EQUIVALENT TO (WATTS)	LUMENS	BEAM ANGLE	MOUNT	COLOR	MODEL NUMBER
110W HIGH LUMEN FLOODLIGHT	110W	250W	12500	107°	BRACKET	4000K	FL-110W-40K-V2
						5000K	FL-110W-50K-V2



Products with this icon are in stock, and ship out on the same day when ordered before 3pm (EST). For latest stock information, please consult [arani.ca](http://arani.ca).

Toll Free: (888) 992-7264 | [arani.ca](http://arani.ca)

## HIGH LUMEN LED FLOOD LIGHTS

42

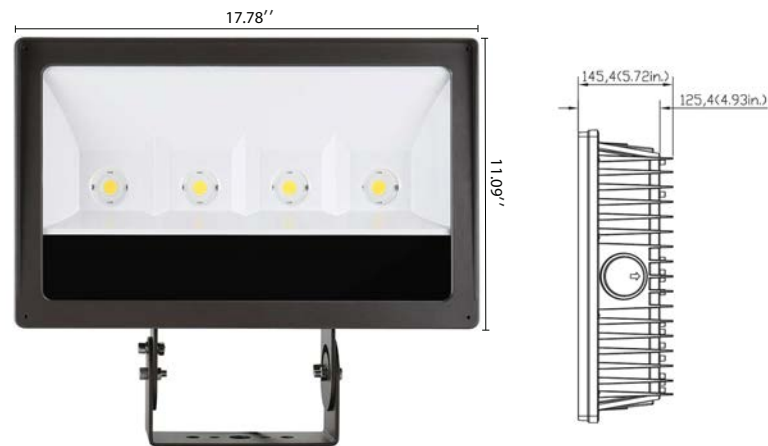
High Lumen  
Flood Lights140W High Lumen Flood Light  
(Bracket)  
FL-140W-xxK-V2

## FEATURES

- Exceptional Lumens/Watt
- CREE LEDs
- Robust Aluminium Casing
- Color Rendering Index: >70
- Operating Temperature: -40°C to 45°C
- Input Voltage: 100-277VAC
- Heatsink for Maximum Lifespan & Performance
- Compatible Slip Fitter Available (See Page 44)

SERIES	POWER (WATTS)	EQUIVALENT TO (WATTS)	LUMENS	BEAM ANGLE	MOUNT	INPUT VOLTAGE	COLOR	MODEL NUMBER
140W HIGH LUMEN	140W	320W	18000	107°	BRACKET	100-277VAC	4000K	FL-140W-40K-V2
							5000K	FL-140W-50K-V2



Products with this icon are in stock, and ship out on the same day when ordered before 3pm (EST). For latest stock information, please consult [arani.ca](http://arani.ca).

Toll Free: (888) 992-7264 | [arani.ca](http://arani.ca)

## HIGH LUMEN LED FLOOD LIGHTS

43

High Lumen  
Flood Lights200W High Lumen Flood Light  
(Bracket)  
FL-200W-xxK-V2

## FEATURES

- Exceptional Lumens/Watt
- CREE LEDs
- Robust Aluminium Casing
- Color Rendering Index: >70
- Operating Temperature: -40°C to 45°C
- Input Voltage: 100-277VAC
- Heatsink for Maximum Lifespan & Performance
- Compatible Slip Fitter Available (See Page 44)

SERIES	POWER (WATTS)	EQUIVALENT TO (WATTS)	LUMENS	BEAM ANGLE	MOUNT	INPUT VOLTAGE	COLOR	MODEL NUMBER
200W HIGH LUMEN	200W	400W	24000	107°	BRACKET	100-277VAC	4000K	FL-200W-40K-V2
							5000K	FL-200W-50K-V2



Products with this icon are in stock, and ship out on the same day when ordered before 3pm (EST). For latest stock information, please consult [arani.ca](http://arani.ca).

Toll Free: (888) 992-7264 | [arani.ca](http://arani.ca)

## HIGH LUMEN LED FLOOD LIGHTS

44

High Lumen  
Flood Lights70W/110W  
Using Slip Fitter  
FL-70W-xxK-V2 + FL-SL-V2  
FL-110W-xxK-V2 + FL-SL-V2140W/200W  
Using Slip Fitter  
FL-140W-xxK-V2 + FL-SL-V2  
FL-200W-xxK-V2 + FL-SL-V2

SERIES	COMPATIBLE WITH		MODEL NUMBER
SLIP FITTER (HIGH LUMEN FLOODLIGHT)	HIGH LUMEN FLOODLIGHTS (70W, 110W, 140W, 200W)	FL-xxW-xxK-V2	FL-SL-V2

Products with this icon are in stock, and ship out on the same day when ordered before 3pm (EST). For latest stock information, please consult [arani.ca](http://arani.ca).Toll Free: (888) 992-7264 | [arani.ca](http://arani.ca)HYBRID  
LED SHOEBOX FLOOD LIGHT  
VERSION 3



## HYBRID LED SHOEBOX FLOOD LIGHT

46

Hybrid Shoebox  
Flood LightsHybrid Shoebox Flood Light (60W/150W)  
with Wall-MountSH-60W-40K-V3 + SH-WM-V3  
SH-150W-xxK-V3 + SH-WM-V3

Slip Fitter &amp; Bracket Available

Lifetime  
50 000 hoursIP65  
Suitable for use in  
wet locations0-10V  
DimmableUL US  
LISTED  
E475776

## FEATURES

Type 5 Lighting Distribution

Type 3 Lighting Distribution Lens Available (SH-LEN-T3-V3)

Robust Die-Cast Aluminium Casing

Color Rendering Index: &gt;70

Operating Temperature: -40°C to 50°C

Poles Available (On Demand)

Must Choose 1 of 3 Mounting Accessories:

Wall-Mount/Slip-Fitter/Bracket (See Page 49)

SERIES	POWER (WATTS)	EQUIVALENT TO (WATTS)	LUMENS	LED QTY	WEIGHT	COLOR TEMP	INPUT VOLTAGE	MODEL NUMBER
60W HYBRID LED SHOEBOX FLOOD LIGHT V3	60	200	9280	140 X EMC3030	5.5kg	4000K	100-277VAC	SH-60W-40K-V3
							347V	SH-60W-40K-V3-347V
150W HYBRID LED SHOEBOX FLOOD LIGHT V3	150	400	20800	140 X EMC3030	5.5kg	4000K	100-277VAC	SH-150W-40K-V3
							347V	SH-150W-40K-V3-347V
						5000K	100-277VAC	SH-150W-50K-V3
							347V	SH-150W-50K-V3-347V

Products with this icon are in stock, and ship out on the same day when ordered before 3pm (EST). For latest stock information, please consult [arani.ca](http://arani.ca).Toll Free: (888) 992-7264 | [arani.ca](http://arani.ca)

## HYBRID LED SHOEBOX FLOOD LIGHT

47

Hybrid Shoebox  
Flood LightsLifetime  
50 000 hoursIP65  
Suitable for use in  
wet locations0-10V  
DimmableUL US  
LISTED  
E475776DLC  
LISTED  
PREMIUM

## FEATURES

Type 5 Lighting Distribution

Type 3 Lighting Distribution Lens Available (SH-LEN-T3-V3)

Robust Die-Cast Aluminium Casing

Color Rendering Index: &gt;70

Operating Temperature: -40°C to 50°C

Poles Available (On Demand)

Must Choose 1 of 3 Mounting Accessories:

Wall-Mount/Slip-Fitter/Bracket (See Page 49)

Hybrid Shoebox Flood Light (200W)  
with Slip Fitter

SH-200W-xxK-V3 + SH-SL-V3

Wall-Mount &amp; Bracket Available

SERIES	POWER (WATTS)	EQUIVALENT TO (WATTS)	LUMENS	LED QTY	WEIGHT	COLOR TEMP	INPUT VOLTAGE	MODEL NUMBER
200W HYBRID LED SHOEBOX FLOOD LIGHT V3	200	600	28000	280 X EMC3030	6.8kg	4000K	100-277VAC	SH-200W-40K-V3
							347V	SH-200W-40K-V3-347V
						5000K	100-277VAC	SH-200W-50K-V3
							347V	SH-200W-50K-V3-347V

Products with this icon are in stock, and ship out on the same day when ordered before 3pm (EST). For latest stock information, please consult [arani.ca](http://arani.ca).Toll Free: (888) 992-7264 | [arani.ca](http://arani.ca)

## HYBRID LED SHOEBOX FLOOD LIGHT

48

Hybrid Shoebox  
Flood LightsHybrid Shoebox Flood Light (300W)  
with Flood Light Bracket  
SH-300W-xxK-V3 + SH-BR-V3  
Wall-Mount & Slip Fitter Available

## FEATURES

Type 5 Lighting Distribution  
Type 3 Lighting Distribution Lens Available (SH-LEN-T3-V3)  
Robust Die-Cast Aluminium Casing  
Color Rendering Index: >70  
Operating Temperature: -40°C to 50°C  
Poles Available (On Demand)

Must Choose 1 of 3 Mounting Accessories:  
Wall-Mount/Slip-Fitter/Bracket (See Page 49)

SERIES	POWER (WATTS)	EQUIVALENT TO (WATTS)	LUMENS	LED QTY	WEIGHT	COLOR TEMP	INPUT VOLTAGE	MODEL NUMBER
300W HYBRID LED SHOEBOX FLOOD LIGHT V3	300	1000	42000	420 X EMC3030	9.6kg	4000K	100-277VAC	SH-300W-40K-V3
							347V	SH-300W-40K-V3-347V
						5000K	100-277VAC	SH-300W-50K-V3
							347V	SH-300W-50K-V3-347V



Products with this icon are in stock, and ship out on the same day when ordered before 3pm (EST). For latest stock information, please consult [arani.ca](http://arani.ca).

Toll Free: (888) 992-7264 | [arani.ca](http://arani.ca)

## HYBRID LED SHOEBOX FLOOD LIGHT ACCESSORIES

49

Hybrid Shoebox  
Flood LightsPhotocell  
SH-CELL-V3

## FEATURES

Easy Installation (Insert and Twist)  
Daylight Sensing

SERIES	COMPATIBLE WITH	MODEL NUMBER
PHOTOCELL FOR HYBRID SHOEBOX FLOOD LIGHT V3	100-277VAC HYBRID SHOEBOX FLOOD LIGHT V3	SH-CELL-V3
	347V HYBRID SHOEBOX FLOOD LIGHT V3	SH-CELL-V3-347V

Slip Fitter  
SH-SL-V3Wall-Mount  
SH-WM-V3Flood Light Bracket  
SH-BR-V3

## FEATURES

Easy Installation (Insert and Screw Down)  
Robust Aluminum Body

Choice of 1 Mounting Accessory Included  
with Every Hybrid Shoebox Flood Light

SERIES	COMPATIBLE WITH	INSTALLATION	APPLICATION	MODEL NUMBER
SLIP FITTER V3	HYBRID SHOEBOX FLOOD LIGHTS V3	Ø2 1/2" ROUND POLE	ALLOWS ADJUSTMENT OF FIXTURE ANGLE	SH-SL-V3
WALL-MOUNT V3	HYBRID SHOEBOX FLOOD LIGHTS V3	WALL/ SQUARE/ROUND POLE	DOES NOT REQUIRE JUNCTION BOX NO FIXTURE ANGLE ADJUSTMENT POSSIBLE	SH-WM-V3
FLOOD LIGHT BRACKET V3	HYBRID SHOEBOX FLOOD LIGHTS V3	WALL/GROUND	ALLOWS ADJUSTMENT OF FIXTURE ANGLE REQUIRES JUNCTION BOX	SH-BR-V3



Products with this icon are in stock, and ship out on the same day when ordered before 3pm (EST). For latest stock information, please consult [arani.ca](http://arani.ca).

Toll Free: (888) 992-7264 | [arani.ca](http://arani.ca)

# LED CANOPY LIGHT

## VERSIONS 3, 4

50

### SLIM PROFILE LED CANOPY LIGHT



Canopy Light  
CL-40K-Vx-xxW



51  
Canopy Light

#### FEATURES

- Slim Profile (2.87")
- Robust Aluminium Casing
- Polycarbonate Lens
- Color Rendering Index: >80
- Operating Temperature: -20°C to 40°C
- Compatible photocell available (PH-1800W-KN)

SERIES	POWER (WATTS)	EQUIVALENT TO (WATTS)	LUMENS	COLOR TEMP	INPUT VOLTAGE	MODEL NUMBER
CANOPY LIGHT VERSION 4	45W	175W	4100	4000K	100-277VAC	CL-40K-V4-45W
					347V	CL-40K-V4-45W-347V
CANOPY LIGHT VERSION 3	65W	250W	6500	4000K	100-277VAC	CL-40K-V3-65W
					347V	CL-40K-V3-65W-347V

Products with this icon are in stock, and ship out on the same day when ordered before 3pm (EST). For latest stock information, please consult [arani.ca](http://arani.ca).

Toll Free: (888) 992-7264 | [arani.ca](http://arani.ca)

# LED VAPOR TIGHT FIXTURE

## VERSION 2

### SHATTER-PROOF LED VAPOR TIGHT FIXTURE



Clip-On Clip-Off  
Stainless Steel Lens

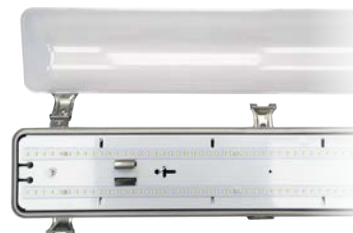



Designed to be Installed

Vapor Tight Fixture  
VT48-42W-xxK-V2



#### FEATURES

- Polycarbonate Clip-On Clip-Off Lens (Hands-Free)
- Circuit Board is Easy to Remove
- Meets Canadian Food Inspection Agency (CFIA) Standards
- Rust-Proof Plastic Body
- Beam Angle: 100°
- Color Rendering Index: >80
- Operating Temperature: -25°C to 45°C

SERIES	POWER (WATTS)	EQUIVALENT TO (WATTS)	LUMENS	INPUT VOLTAGE	COLOR TEMP	MODEL NUMBER
VAPOR TIGHT FIXTURE V2	42	100	5000	100-277V AC	4000K	VT48-42W-40K-V2 
					5000K	VT48-42W-50K-V2 
				347V	4000K	VT48-42W-40K-V2-347V
					5000K	VT48-42W-50K-V2-347V 

 Products with this icon are in stock, and ship out on the same day when ordered before 3pm (EST). For latest stock information, please consult [arani.ca](http://arani.ca).

Toll Free: (888) 992-7264 | [arani.ca](http://arani.ca)



54

# SIGNATURE LED WALL PACKS

## SIGNATURE LED WALL PACKS

55

LED  
Wall Packs



Wall Pack 2  
WP2-xxW-50K-V3  
WP2-xxK-Vx-347V



### FEATURES

- Class I Luminaire
- Robust Aluminium Casing
- Polycarbonate Lens
- Color Rendering Index: >75
- Operating Temperature: -40°C to 50°C
- Compatible photocell available (PH-1800W-KN)

SERIES	POWER (WATTS)	EQUIVALENT TO (WATTS)	LUMENS	COLOR TEMP	INPUT VOLTAGE	MODEL NUMBER
WALL PACK 2 (40W)	40	150	4800	5000K	120-277VAC	WP2-40W-50K-V3
	45	150	5300	5000K	347V	WP2-50K-V1-347V
WALL PACK 2 (60W)	60	250	7200	5000K	120-277VAC	WP2-60W-50K-V3
	70	250	8100	5000K	347V	WP2-50K-V2-347V
WALL PACK 2 (120W)	120	400	14400	5000K	120-277VAC	WP2-120W-50K-V3

Products with this icon are in stock, and ship out on the same day when ordered before 3pm (EST). For latest stock information, please consult [arani.ca](http://arani.ca).

Toll Free: (888) 992-7264 | [arani.ca](http://arani.ca)

## SIGNATURE LED WALL PACKS

56

LED  
Wall Packs

Wall Pack 7  
Adjustable Motion Sensor &  
Photocell Technology  
WP7



Lifetime  
50 000 hours



IP66  
Suitable for use in  
wet locations



Wall Pack 10  
Photocell Technology  
WP10

## FEATURES

Class I Luminaires  
Robust Aluminium Casing  
Polycarbonate Lens  
Color Rendering Index: >75  
Operating Temperature: -40°C to 50°C  
Input Voltage: 120-277VAC

SERIES	POWER (WATTS)	EQUIVALENT TO (WATTS)	LUMENS	LED QTY	COLOR TEMP	MODEL NUMBER
WALL PACK 7	14	50	1200	1	4000K	WP7
WALL PACK 10	17	50	1700	24	4000K	WP10



Products with this icon are in stock, and ship out on the same day when ordered before 3pm (EST). For latest stock information, please consult [arani.ca](http://arani.ca).

Toll Free: (888) 992-7264 | [arani.ca](http://arani.ca)

## SIGNATURE LED WALL PACKS

57

LED  
Wall Packs

Wall Pack 11 (30W)  
Photocell Technology  
WP11-30W-50K



Wall Pack 11 (70W)  
Photocell Technology  
WP11-70W-50K



Lifetime  
50 000 hours



IP66  
Suitable for use in  
wet locations



## FEATURES

Class II Luminaire  
0 to >90° Adjustable Tilt  
Robust Aluminium Casing  
Glass Lens  
Color Rendering Index: >75  
Operating Temperature: -40°C to 50°C  
Input Voltage: 120VAC

SERIES	POWER (WATTS)	EQUIVALENT TO (WATTS)	LUMENS	LED QTY	COLOR TEMP	MODEL NUMBER
WALL PACK 11	30	100	3000	1	5000K	WP11-30W-50K
	70	250	7800	2	5000K	WP11-70W-50K



Products with this icon are in stock, and ship out on the same day when ordered before 3pm (EST). For latest stock information, please consult [arani.ca](http://arani.ca).

Toll Free: (888) 992-7264 | [arani.ca](http://arani.ca)



# WATERPROOF LED WALL WASHER

## WATERPROOF LED WALL WASHER



2  
years  
Limited  
Warranty



Lifetime  
20 000 hours



IP65  
Suitable for use in  
wet locations



UL  
LISTED  
E475776



Wall Washer  
WW-48-48W-40K

### FEATURES

Robust Aluminium Casing

Tempered Glass Lens

Beam Angle: 45°

Color Rendering Index: >80

Operating Temperature: -25°C to 40°C

Input Voltage: 90-130V

SERIES	POWER (WATTS)	EQUIVALENT TO (WATTS)	LUMENS	LED QTY	COLOR TEMP	MODEL NUMBER
WATERPROOF WALL WASHER	48	150	3360	48	4000K	WW-48-48W-40K



Products with this icon are in stock, and ship out on the same day when ordered before 3pm (EST). For latest stock information, please consult [arani.ca](http://arani.ca).

Toll Free: (888) 992-7264 | [arani.ca](http://arani.ca)



COMMERCIAL

INDUSTRIAL

# LED HIGH BAYS

## SIGNATURE LED HIGH BAY

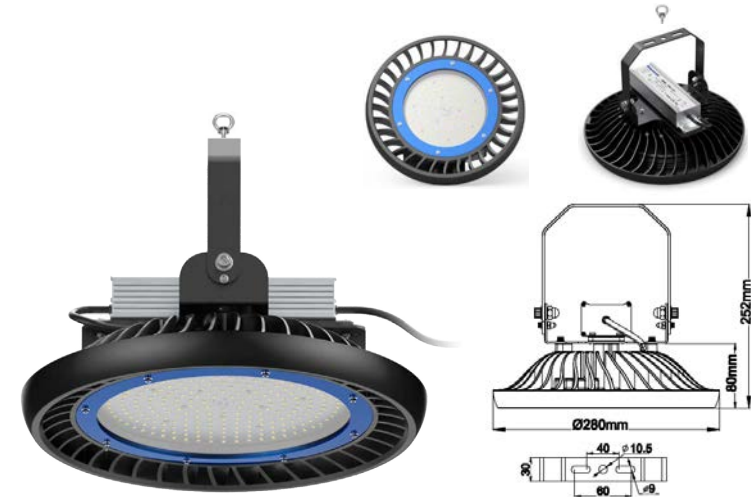

LED High Bay  
HB-xxxW-xxK-DS

100W LED High Bay  
HB-100W-xxK-DS

5 years  
Limited  
Warranty

Lifetime  
50 000 hours

IP65  
Suitable for use in  
wet locations

0-10V  
Dimmable

UL US  
LISTED  
E475776

DLC OPT  
LISTED  
PREMIUM

### FEATURES

- Bracket/Hook Mount
- External Driver for Easy Access
- Robust Aluminium Casing with Polycarbonate Cover
- Color Rendering Index: >70
- Operating Temperature: -20°C to 55°C
- Beam Angle: 110°
- Compatible Reflector Available (See Page 63)

SERIES	POWER (WATTS)	EQUIVALENT TO (WATTS)	LUMENS	LED QTY	COLOR TEMP	INPUT VOLTAGE	MODEL NUMBER
100W LED HIGH BAY	100	200	15500	196 x SMD3030	4000K	100-277VAC	HB-100W-40K-DS
						347V	HB-100W-40K-DS-347V
					5000K	100-277VAC	HB-100W-50K-DS
						347V	HB-100W-50K-DS-347V

Products with this icon are in stock, and ship out on the same day when ordered before 3pm (EST). For latest stock information, please consult [arani.ca](http://arani.ca).

Toll Free: (888) 992-7264 | [arani.ca](http://arani.ca)

RESIDENTIAL

COMMERCIAL

INDUSTRIAL



## SIGNATURE LED HIGH BAY

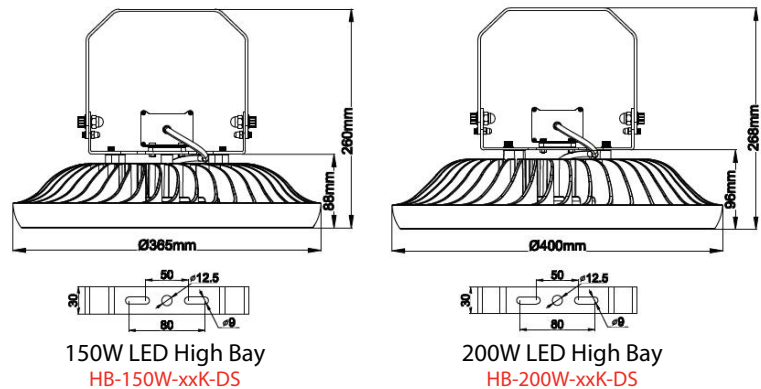

150W LED High Bay  
HB-150W-xxK-DS

200W LED High Bay  
HB-200W-xxK-DS



5 years

Limited Warranty

Lifetime  
50 000 hoursIP65  
Suitable for use in  
wet locations0-10V  
DimmableUL LISTED  
E475776

DLC PREMIUM

62

LED  
High Bays

## FEATURES

Bracket/Hook Mount

External Driver for Easy Access

Robust Aluminium Casing with Polycarbonate Cover

Operating Temperature: -20°C to 55°C

Beam Angle: 110°

Compatible reflector available (See Page 63)

SERIES	POWER (WATTS)	EQUIVALENT TO (WATTS)	LUMENS	LED QTY	COLOR TEMP	INPUT VOLTAGE	MODEL NUMBER
150W LED HIGH BAY	150	330	22000	252 x SMD3030	4000K	100-277VAC	HB-150W-40K-DS
						347V	HB-150W-40K-DS-347V
					5000K	100-277VAC	HB-150W-50K-DS
						347V	HB-150W-50K-DS-347V
200W LED HIGH BAY	200	400	30000	336 x SMD3030	4000K	100-277VAC	HB-200W-40K-DS
						347V	HB-200W-40K-DS-347V
					5000K	100-277VAC	HB-200W-50K-DS
						347V	HB-200W-50K-DS-347V



Products with this icon are in stock, and ship out on the same day when ordered before 3pm (EST). For latest stock information, please consult [arani.ca](http://arani.ca).

Toll Free: (888) 992-7264 | [arani.ca](http://arani.ca)

## LED HIGH BAY ACCESSORIES

63

LED  
High Bays

Compatible Reflector  
HB-AC-RL-DS-xxx

## FEATURES

Easy Installation (5 Screws)

Reduces Glare

Changes LED High Bay Beam Angle to 90°

Lightweight Aluminum Body

SERIES	COMPATIBLE WITH	BEAM ANGLE	MATERIAL	FINISH	MODEL NUMBER
REFLECTOR FOR LED HIGH BAYS	100W HIGH BAYS	90°	ALUMINUM	SILVER	HB-AC-RL-DS-100
				WHITE	HB-AC-RL-DS-W-100
	150W HIGH BAYS	90°	ALUMINUM	SILVER	HB-AC-RL-DS-150
				WHITE	HB-AC-RL-DS-W-150
	200W HIGH BAYS	90°	ALUMINUM	SILVER	HB-AC-RL-DS-200
				WHITE	HB-AC-RL-DS-W-200



Products with this icon are in stock, and ship out on the same day when ordered before 3pm (EST). For latest stock information, please consult [arani.ca](http://arani.ca).

Toll Free: (888) 992-7264 | [arani.ca](http://arani.ca)

# LED TUBES

## T5 / T8 TUBES

64

### BALLAST COMPATIBLE LED T5 TUBES

65



  
LED  
T5 Tubes

T5 Tube V2  
Traditional Glass Lens  
T48T5-xxK-V2

5  
yearsLimited  
WarrantyLifetime  
50 000 hoursIP40  
Suitable for use in  
damp locationsUL  
LISTED  
E342282DLC  
LISTED

#### FEATURES

- Compatible with Most Electronic Ballasts
- Robust Aluminium Casing
- Beam Angle: 180°
- Color Rendering Index: >75
- Operating Temperature: -10°C to 40°C

SERIES	LENGTH	PINS	POWER (WATTS)	EQUIVALENT TO (WATTS)	LUMENS	INPUT VOLTAGE	COLOR TEMP	MODEL NUMBER
T5 TUBES V2	4FT	2	25	50	3500	Electronic Ballast	3000K	T48T5-30K-V2
							4000K	T48T5-40K-V2 
							5000K	T48T5-50K-V2 



Products with this icon are in stock, and ship out on the same day when ordered before 3pm (EST). For latest stock information, please consult [arani.ca](http://arani.ca).

Toll Free: (888) 992-7264 | [arani.ca](http://arani.ca)

## BALLAST COMPATIBLE LED T8 TUBES

66

LED  
T8 TubesT8 Tube V6  
Polycarbonate Lens  
TxxT8-xxK-V6

## FEATURES

Compatible with Most Electronic Ballasts

Robust Aluminium Casing

Beam Angle: 180°

Color Rendering Index: &gt;75

Operating Temperature: -10°C to 40°C

SERIES	LENGTH	PINS	POWER (WATTS)	EQUIVALENT TO (WATTS)	LUMENS	COLOR TEMP	INPUT VOLTAGE	MODEL NUMBER
T8 TUBES V6	2FT	2	8	15	1000	4000K	Electronic Ballast	T24T8-40K-V6
	4FT	2	18	30	2270	4000K	Electronic Ballast	T48T8-40K-V6
						5000K	Electronic Ballast	T48T8-50K-V6

Products with this icon are in stock, and ship out on the same day when ordered before 3pm (EST). For latest stock information, please consult [arani.ca](http://arani.ca).Toll Free: (888) 992-7264 | [arani.ca](http://arani.ca)

## BALLAST BYPASS LED T8 TUBES

67

LED  
T8 TubesT8 Tube V2  
8FT, 1 Pin  
T96T8-41K-V2-1P

## FEATURES

Hardwire Only

Robust Aluminium Casing

Color Rendering Index: &gt;75

Operating Temperature: -10°C to 40°C

SERIES	LENGTH	PINS	POWER (WATTS)	EQUIVALENT TO (WATTS)	LUMENS	COLOR TEMP	INPUT VOLTAGE	MODEL NUMBER
VERSION 2 T8 TUBES	8FT	1	31	60	3960	4100K	100-277V	T96T8-41K-V2
		2	31	60	3960	4100K	100-277V	T96T8-41K-V2-1P
							347V	T96T8-41K-V2-347V

Products with this icon are in stock, and ship out on the same day when ordered before 3pm (EST). For latest stock information, please consult [arani.ca](http://arani.ca).Toll Free: (888) 992-7264 | [arani.ca](http://arani.ca)



# SIGNATURE LED LAMPS



## SIGNATURE LED LAMPS



BA19-27K-V6



2 years Limited Warranty



Lifetime 15 000 hours



IP54 Suitable for use in damp locations



Dimmable



LISTED E338787

### FEATURES

LED Filament

Operating Temperature: -20°C to 40°C

SERIES	BASE	POWER (WATTS)	EQUIVALENT TO (WATTS)	LUMENS	INPUT VOLTAGE	COLOR	BEAM ANGLE	CRI	MODEL NUMBER
FILAMENT A19 V6	E26	7.5	50	750	120VAC	2700K	360°	82.1	BA19-27K-V6

Products with this icon are in stock, and ship out on the same day when ordered before 3pm (EST). For latest stock information, please consult [arani.ca](http://arani.ca).

Toll Free: (888) 992-7264 | [arani.ca](http://arani.ca)

## SIGNATURE LED LAMPS

70

LED  
Lamps5  
years  
Limited  
Warranty

Dimmable

Lifetime  
50 000 hoursIP54  
Suitable for use in  
damp locationsLISTED  
E338787Energy Star Approved:  
BPAR20-xxK-V7

## FEATURES

Concealed Heat Sinks  
Input Voltage: 90-130V AC  
Operating Temperature: -25°C to 40°C

SERIES	BASE	POWER (WATTS)	EQUIVALENT TO (WATTS)	LUMENS	CRI	BEAM ANGLE	COLOR	MODEL NUMBER
PAR16 LAMP V7	E26	7	50	550	94.6	40°	3000K	BPAR16-30K-V7
							4000K	BPAR16-40K-V7
PAR20 LAMP V7	E26	7	50	600	94.0	40°	3000K	BPAR20-30K-V7
							4000K	BPAR20-40K-V7
PAR30 LAMP V8 SHORT NECK	E26	10	75	800	80<	40°	3000K	BPAR30-30K-V8-SN



Products with this icon are in stock, and ship out on the same day when ordered before 3pm (EST). For latest stock information, please consult [arani.ca](http://arani.ca).

Toll Free: (888) 992-7264 | [arani.ca](http://arani.ca)

## SIGNATURE LED LAMPS

71

LED  
Lamps5  
years  
Limited  
WarrantyLifetime  
50 000 hoursIP66  
Suitable for use in  
wet locations

Dimmable

LISTED  
E338787

## FEATURES

Concealed Heat Sinks  
Input Voltage: 90-130V AC  
Operating Temperature: -25°C to 40°C

SERIES	BASE	POWER (WATTS)	EQUIVALENT TO (WATTS)	LUMENS	CRI	BEAM ANGLE	COLOR	MODEL NUMBER
PAR30 LAMP V8	E26	10	75	800	80<	40°	3000K	BPAR30-30K-V8
				900	80<	40°	4000K	BPAR30-40K-V8
PAR38 LAMP V8	E26	13	120	1100	80<	40°	3000K	BPAR38-30K-V8
				1200	80<	40°	4000K	BPAR38-40K-V8



Products with this icon are in stock, and ship out on the same day when ordered before 3pm (EST). For latest stock information, please consult [arani.ca](http://arani.ca).

Toll Free: (888) 992-7264 | [arani.ca](http://arani.ca)

## SIGNATURE LED LAMPS

72



## FEATURES

Operating Temperature: -25°C to 40°C

MR11 Lamp V1



SERIES	BASE	POWER (WATTS)	EQUIVALENT TO (WATTS)	LUMENS	INPUT VOLTAGE	CRI	BEAM ANGLE	COLOR	MODEL NUMBER
MR11 LAMP V1	MR11	2	10	75	12V	>80	45°	3000K	BMR11-30K-V1
								6000K	BMR11-60K-V1



## FEATURES

Operating Temperature: -20°C to 40°C

G4 Lamp V5

G9 Lamp V2



SERIES	BASE	POWER (WATTS)	EQUIVALENT TO (WATTS)	LUMENS	INPUT VOLTAGE	CRI	BEAM ANGLE	COLOR	MODEL NUMBER
G4 LAMP V5	G4	1.5	10	130	12AC/DC	>80	330°	3000K	BG4-30K-V5
								4000K	BG4-40K-V5
G9 LAMP V2	G9	3	20	300	120V AC	>80	330°	3000K	BG9-30K-V2
								4000K	BG9-40K-V2



Products with this icon are in stock, and ship out on the same day when ordered before 3pm (EST). For latest stock information, please consult [arani.ca](http://arani.ca).

Toll Free: (888) 992-7264 | [arani.ca](http://arani.ca)

## SIGNATURE LED LAMPS

73



Energy Star Approved: BGU10-xxK-V7

## FEATURES

Concealed Heat Sinks

Operating Temperature: -25°C to 40°C

MR16 Lamp V5

GU10 Lamp V7

A19 Lamp V8

SERIES	BASE	POWER (WATTS)	EQUIVALENT TO (WATTS)	LUMENS	INPUT VOLTAGE	CRI	BEAM ANGLE	COLOR	MODEL NUMBER
MR16 LAMP V5	MR16	7	50	500	12V	91.5	40°	3000K	BMR16-30K-V5
								4000K	BMR16-40K-V5
GU10 LAMP V7	GU10	7.5	75	550	120V AC	92.8	40°	3000K	BGU10-30K-V7
				600	120V AC	92.8	40°	4000K	BGU10-40K-V7
BA19 LAMP V8	E26	10	60	800	90-130V AC	>80	240°	2700K	BA19-27K-V8
								3000K	BA19-30K-V8
								4000K	BA19-40K-V8



Products with this icon are in stock, and ship out on the same day when ordered before 3pm (EST). For latest stock information, please consult [arani.ca](http://arani.ca).

Toll Free: (888) 992-7264 | [arani.ca](http://arani.ca)



74

# LED ACCESSORIES

## LED ACCESSORIES

75

LED  
AccessoriesSuitable for use in  
dry locations

### FEATURES

Operating Temperature: -5°C to 45°C

Efficiency: 85%

SERIES	POWER (WATTS)	INPUT VOLTAGE	OUTPUT	MAX OUTPUT CURRENT (A)	DIMENSIONS	MODEL NUMBER
PLUGIN 12 VOLT TRANSFORMERS	30	90-130V AC	12V DC	2.12	4.65" x 2" x 1.2" (118mm x 50mm x 30mm)	DR-12V-30W
	60	90-130V AC	12V DC	4.25	4.65" x 2" x 1.2" (118mm x 50mm x 30mm)	DR-12V-60W
	96	90-130V AC	12V DC	6.8	6.5" x 2.4" x 1.4" (165mm x 60mm x 35mm)	DR-12V-96W

Products with this icon are in stock, and ship out on the same day when ordered before 3pm (EST). For latest stock information, please consult [arani.ca](http://arani.ca).Toll Free: (888) 992-7264 | [arani.ca](http://arani.ca)

## LED ACCESSORIES

76



LED Accessories



DR-60W-MG



DR-150W-MG



DR-24V-60W-MG



DR-24V-150W-MG

5 years  
Limited  
Warranty



Suitable for use in  
dry locations

Low Voltage  
Magnetic Dimmer  
Dimmable



FEATURES

Operating Temperature: -40°C to 45°C

Efficiency: 85%

SERIES	POWER (WATTS)	INPUT VOLTAGE	OUTPUT VOLTAGE	INPUT LEADS	OUTPUT LEADS	MAX OUTPUT CURRENT (A)	DIMENSIONS	MODEL NUMBER
DIMMABLE 12V HARDWIRE MAGNETIC TRANSFORMERS	60	120V AC	12V	#20 AWG	#14 AWG	4.8	4.65" x 2" x 1.2" (118mm x 50mm x 30mm)	DR-60W-MG
	150	120V AC	12V	#18 AWG	#12 AWG	12.35	9.45" x 3.2" x 3.2" (240mm x 80mm x 80mm)	DR-150W-MG
DIMMABLE 24V HARDWIRE MAGNETIC TRANSFORMERS	60	130V AC	24V	#20 AWG	#14 AWG	2.5	4.65" x 2" x 1.2" (118mm x 50mm x 30mm)	DR-24V-60W-MG
	150	130V AC	24V	#18 AWG	#12 AWG	6.25	9.45" x 3.2" x 3.2" (240mm x 80mm x 80mm)	DR-24V-150W-MG



Products with this icon are in stock, and ship out on the same day when ordered before 3pm (EST). For latest stock information, please consult [arani.ca](http://arani.ca).

Toll Free: (888) 992-7264 | [arani.ca](http://arani.ca)

## LED ACCESSORIES

77



LED Accessories



2 years  
Limited  
Warranty



Suitable for use in  
dry locations

Triac/Phase-Cut  
Dimmable  
(DR-12V-xxW-HW-V2)



FEATURES

Operating Temperature: -5°C to 45°C

Efficiency: 85%

SERIES	POWER (WATTS)	INPUT VOLTAGE	OUTPUT VOLTAGE	DIMENSIONS	MODEL NUMBER
12 VOLT HARDWIRE ELECTRONIC TRANSFORMERS	12	90-130V AC	12V	3.00" x 1.5" x 1.25" (76mm x 38mm x 32mm)	DR-12V-12W
	60	100-130V ~1.0A MAX 50/60Hz	12V	9.80" x 3.86" x 1.50" (249mm x 98mm x 38mm)	DR-12V-60W-HW-V2
	150	100-130V ~2.4A MAX 50/60Hz	12V	15.25" x 3.25" x 2.5" (390mm x 83mm x 58mm)	DR-12V-150W-HW-V2

FEATURES

Operating Temperature: -30°C to 55°C



2 years  
Limited  
Warranty



Suitable for use in  
dry locations

SERIES	MAX POWER (WATTS)	INPUT/OUTPUT VOLTAGE	MAX OUTPUT CURRENT (A)	DIMENSIONS	MODEL NUMBER
RGBW RF CONTROLLER WITH REMOTE	144	12V DC	6 /CH	3.35" x 1.77" x 0.87" (85mm x 45mm x 22mm)	RGBWCTRL-144W-RF
RGBW AMPLIFIER	288	12V	6 /CH	3.19" x 2.52" x 0.95" (81mm x 64mm x 24mm)	RGBWAMP-12V

RESIDENTIAL

COMMERCIAL

INDUSTRIAL

RESIDENTIAL

COMMERCIAL

INDUSTRIAL





# ELECTRICAL DEVICES & HARDWARE

## ELECTRICAL DEVICES & HARDWARE



DR-347V-240-50W  
DR-347V-120-25W



DR-347V-240-100W  
DR-347V-120-60W



IP44  
Suitable for use in damp locations



### FEATURES

Fits in 4" Junction Box

Operating Temperature: -20°C to 50°C

Efficiency: 89%

SERIES	INPUT VOLTAGE	OUTPUT	POWER (WATTS)	DIMENSIONS	MODEL NUMBER
STEP DOWN DRIVERS	347V	240V AC	50	1.57" x 1.69" x 1.30" (40mm x 43mm x 33mm)	DR-347-240-50W
			100	3.15" x 1.65" x 1.50" (80mm x 42mm x 38mm)	DR-347-240-100W
		120V AC	25	1.57" x 1.69" x 1.30" (40mm x 43mm x 33mm)	DR-347-120-25W
			60	3.15" x 1.65" x 1.50" (80mm x 42mm x 38mm)	DR-347-120-60W

Products with this icon are in stock, and ship out on the same day when ordered before 3pm (EST). For latest stock information, please consult [arani.ca](http://arani.ca).

## ELECTRICAL DEVICES &amp; HARDWARE



ED-OJB-54151-L



ED-OJB-54151-LA



ED-OJB-54151-K



ED-OJB-56111



ED-SJB-52171-K



ED-SJB-72171-K

1  
year  
Limited  
WarrantyFEATURES  
Standard Sizes  
Robust Metal Construction

SERIES	SIZE	TYPE	MODEL NUMBER
OCTAGONAL JUNCTION BOXES	Ø 4"	CLAMPS	ED-OJB-54151-L
		CLAMPS	ED-OJB-54151-LA
		1/2" & 3/4" KNOCKOUTS	ED-OJB-54151-K
		PANCAKE BOX	ED-OJB-56111
SQUARE JUNCTION BOXES	4" WIDE	KNOCKOUTS	ED-SJB-52171-K
	4 11/16" WIDE	KNOCKOUTS	ED-SJB-72171-K

Products with this icon are in stock, and ship out on the same day when ordered before 3pm (EST). For latest stock information, please consult [arani.ca](http://arani.ca).

Toll Free: (888) 992-7264 | [arani.ca](http://arani.ca)

80

Electrical  
Devices

## ELECTRICAL DEVICES &amp; HARDWARE



ED-NGU-1110



ED-NGB-2104-LLE



ED-NGB-2104-LLE2



ED-NGB-2104-LLE3



ED-GGB-1104-LH



ED-GGB-1304-LH



ED-SSB-2104-LSSAX



ED-GGB-1004-LH

1  
year  
Limited  
WarrantyFEATURES  
Standard Sizes  
Robust Metal Construction

SERIES	SIZE	TYPE	MODEL NUMBER
SWITCH/UTILITY BOXES	1 7/8" DEEP	NON-GANGABLE UTILITY BOX WITH KNOCKOUTS	ED-NGU-1110
		1 GANG DEVICE BOX WITH CLAMPS	ED-NGB-2104-LLE
		2 GANG DEVICE BOX WITH CLAMPS	ED-NGB-2104-LLE2
	2 1/2" DEEP	3 GANG DEVICE BOX WITH CLAMPS	ED-NGB-2104-LLE3
		DEVICE BOX WITH CLAMPS	ED-GGB-1104-LH
		"BUBBLE" BOX WITH CLAMPS	ED-GGB-1304-LH
		NON-GANGABLE STEEL STUD BOX WITH WRAPAROUND BRACKET	ED-SSB-2104-LSSAX
		3" DEEP	DEVICE BOX WITH CLAMPS

Products with this icon are in stock, and ship out on the same day when ordered before 3pm (EST). For latest stock information, please consult [arani.ca](http://arani.ca).

Toll Free: (888) 992-7264 | [arani.ca](http://arani.ca)

81

Electrical  
Devices

## ELECTRICAL DEVICES &amp; HARDWARE

82

Electrical  
Devices

ED-RBC-54C1



ED-SBC-52C1



ED-SBC-72C1



ED-UBC-11C4



ED-UBC-11C5



ED-UBC-11C1

FEATURES  
Standard Sizes  
Robust Metal Construction

SERIES	SIZE	TYPE	MODEL NUMBER
ROUND COVER	Ø 4"	FULL COVER	ED-RBC-54C1
SQUARE COVER	4" WIDE	FULL COVER	ED-SBC-52C1
	4 11/16" WIDE	FULL COVER	ED-SBC-72C1
UTILITY BOX COVER	2 3/8" WIDE	FULL COVER	ED-UBC-11C4
		SINGLE SWITCH	ED-UBC-11C5
		DUPLEX OUTLET	ED-UBC-11C1

 Products with this icon are in stock, and ship out on the same day when ordered before 3pm (EST). For latest stock information, please consult [arani.ca](http://arani.ca).Toll Free: (888) 992-7264 | [arani.ca](http://arani.ca)

## ELECTRICAL DEVICES &amp; HARDWARE

83

Electrical  
Devices

ED-NBC-4004



ED-MBC-L16



ED-MBC-L17



ED-MBC-CI-2175

FEATURES  
Standard Sizes  
Robust Metal/Nylon Construction

SERIES	KNOCKOUT SIZE	MATERIAL	TYPE	MODEL NUMBER
BOX CONNECTORS	1/2"	NYLON	1/2" SNAP IN	ED-NBC-4004
		METAL	1 SCREW 3/8"	ED-MBC-L16
			1 SCREW 1/2"	ED-MBC-L17
			3/8" DUPLEX	ED-MBC-CI-2175

 Products with this icon are in stock, and ship out on the same day when ordered before 3pm (EST). For latest stock information, please consult [arani.ca](http://arani.ca).Toll Free: (888) 992-7264 | [arani.ca](http://arani.ca)



# ARANI Energy Analysis

## PAST PROJECTS

ULTRAMAR  
(300+ Locations)

Molson

Groupe Canam  
(Canada and the United States)

Rio Tinto

Town of Acton Vale  
and 9 Other Municipalities

Over 100 Independent  
Projects in Canada and  
the United States

Arani offers a **complete turnkey lighting energy analysis solution** for commercial and industrial projects in Quebec. Each project consists of the following parts:

1. Lighting Systems Inventory
2. Analysis of Historical Lighting Energy Consumption
3. Presentation of Approved Products for Retrofit Projects
4. Preapproval for Credit Incentives
5. Full Lighting Simulation Plans
6. Comparative Savings Analysis
7. Submission of Documentation to Legal Entities for Credit Incentives
8. Delivery of Lighting Products

**On average, recuperating your investment takes only 2 or 3 years.  
To find out how much you can save, contact us today!**

## See your project come to life

Arani offers **full project simulation services** on all Arani products for your lighting needs. Simply provide project specifications to receive product and installation recommendations, and a full project report, free of charge!

### Use our service to:

1. Determine the right products for your project
2. Determine the perfect placement of your luminaires
3. Show your customers the lighting blueprint

**ALL BEFORE YOU INSTALL THE PRODUCTS  
AT THE JOB SITE!**

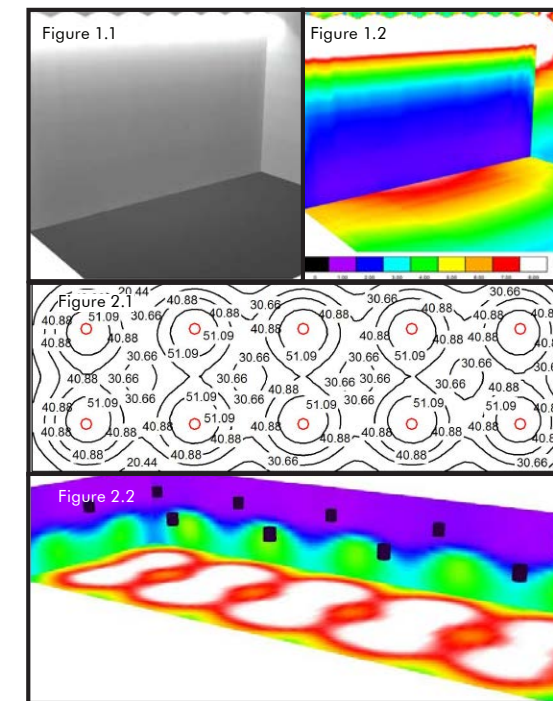

Fig 1: Simulation of Arani Floodlights in a Theatre  
1.1: 3D Rendering  
1.2: False Color Rendering

Fig 2: Simulation of Arani Highbays in a Warehouse  
2.1: Lighting Summary  
2.2: False Color Rendering



Arani is proud of our quality control and research & development. Our AraniLab houses our Sphere, 2 meters in diameter and one of the few of its size in Canada, for all of your spec-related needs. To use our lab resources or receive a lab report, contact us.

You can now order your strips and extrusions by the inch for your custom projects.



### Superior Product Selection

Choose from a wide range of strips and extrusions that are perfect for your custom needs. With 22 strip options, 2 all-purpose surface mount extrusions, and our very own premium LUNAR recessed lighting solution, we've got you covered for any project.

### Made to Measure



With Arani, you don't have to do it yourself to get the job done right. Let us know the quantities and desired lengths for each strip and extrusion, and our in-house specialists will ensure you receive the exact products for your requirements.



### Plug & Light Experience

Arani believes using our products and services should be as easy as possible; our custom strips and extrusions service is no exception. Get a taste of Arani's Plug & Light Experience now!





# COLOR TEMPERATURE REFERENCE

88



2200K

Amber White

2500K

Sunrise/Sunset  
White

2700K

Soft White

3000K

Warm White

3500K

Neutral White

4000/4100K

Cool White

5000K

Daylight

6500K

Daylight

89

## Limited Warranty

Arani guarantees that its products will be free from defects in material and workmanship and will operate for the number of years mentioned when used in accordance with usage and installation directions. If its products do not conform to the warranty, Arani will provide a replacement or refund upon receipt of the returned product and proof of purchase.

Please consult our website for details on returning a product. Arani is committed to making high-quality products. Returning a defective product will help us monitor and further improve product quality. This limited warranty does not cover products subject to accident, neglect, abuse, misuse, or acts of God.





LED LIGHTING PRODUCTS

WINTER 2019

Head Office

5579 Rue Paré

Montréal, QC H4P 1P7

Canada

Toll Free: (888) 992-7264 | [arani.ca](http://arani.ca)