

## WARNINGS



### RISK OF FIRE, ELECTRICAL SHOCK, CUTS OR OTHER CASUALTY HAZARDS

Installation and maintenance of this product must be performed by a qualified electrician. This product must be installed in accordance with the applicable installation code by a person familiar with the construction and operation of the product and hazards involved.

### RISK OF FIRE AND ELECTRIC SHOCK

Make certain power is OFF before starting installation or attempting any maintenance. Disconnect power at fuse or circuit breaker.

### RISK OF FIRE

Refer to product label for specific minimum supply conductor requirements.

### RISK OF BURN

Disconnect power and allow fixture to cool before handling or servicing.

### RISK OF PERSONAL INJURY

Fixture may become damaged and/or unstable if not installed properly.

**DISCLAIMER OF LIABILITY:** CSC LED assumes no liability for damages or losses of any kind that may arise from the improper, careless, or negligent installation, handling or use of this product.

**NOTICE:** Green ground wire is provided in proper location. Do not relocate.

**SAFETY:** This fixture must be wired in accordance with the National Electrical Code and applicable local codes and ordinances. Proper grounding is required to ensure personal safety. Carefully observe grounding procedure under installation section.

**APPLICATIONS:** This lighting fixture is designed for indoor lighting applications, and should not be used in an area with limited ventilation or inside high ambient temperature enclosures. It must be stored in a dry location prior to installation.

**ATTENTION RECEIVING DEPARTMENT:** Note actual fixture description of any shortage or noticeable damage on delivery receipt. File claim for common carrier (LTL) directly with carrier. Claims for concealed damage must be filed within 15 days of delivery. All damaged material, complete with original packaging must be retained.

## WIRING DIAGRAM

L: Black  
N: White  
⊕: Green/Yellow  
Dim(+): Purple  
Dim(-): Pink

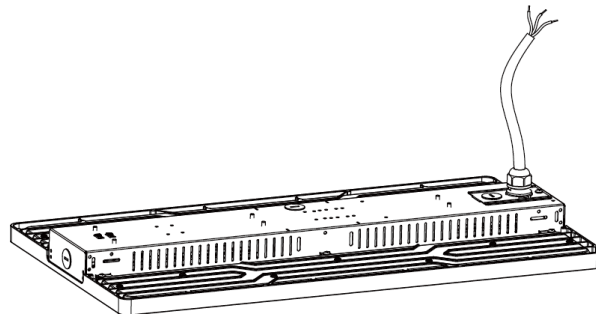

**NOTE:** Please cap the dim and AUX cables if not in use.

## SUSPENDED INSTALLATION

1. Secure the chain to the V-hook. (Fig. 1)
2. Adjust the chain length as needed by removing the links.
3. Install the V-hook on each end of the luminaire. (Fig. 1)
4. After securely hanging the fixture, select a suitable wiring knock out and connect the wires as per the wiring diagram and local code. (Fig. 2)

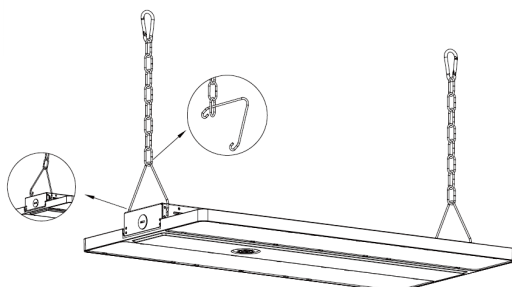

Fig. 1

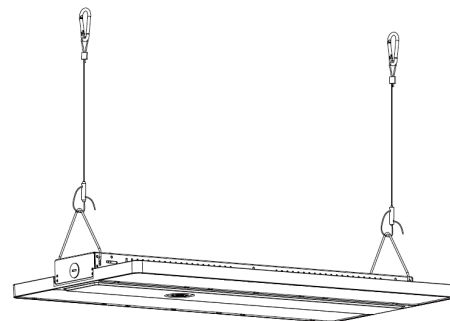

Fig. 2

## 3/4" NPT INSTALLATION

1. Mount the bracket to 3/4" NPT conduit. (Fig. 3)
2. Lock the bracket to the luminaire. (Fig. 4)
3. Connect the wires as per the wiring diagram and local code.
4. Lock side brackets with screwdriver. (Fig. 5)

**NOTE:** An emergency driver **cannot** be used with this installation.



Fig. 3

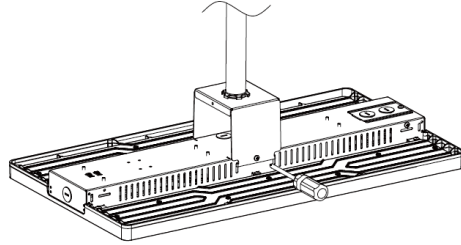

Fig. 4

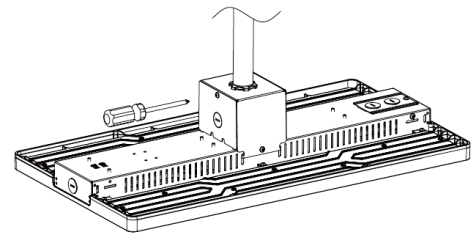

Fig. 5

## SURFACE MOUNTING

1. Mount the brackets and secure them with a bolt to the strut rail or ceiling. (Fig. 6)
2. Install the luminaire to the brackets and affix it with screws. (Fig. 7)
3. Choose a suitable wiring knock out and connect the wires as per the wiring diagram and local code.

**NOTE:** An emergency driver **cannot** be used with this installation.

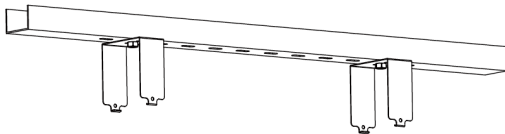

Fig. 6

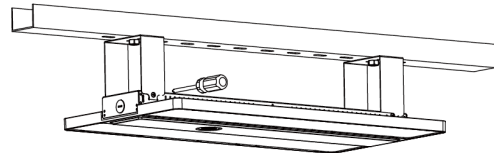

Fig. 7

## WIRE GUARD INSTALLATION

Place the wire guard over the top of the luminaire and affix it with screws on the side. (Fig. 8)

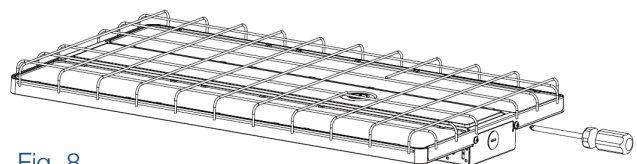

Fig. 8

## INSTALLATION OF DC MOTION SENSOR

Using a screwdriver, unscrew the 1/2" knockout and screw on the motion sensor (MS01-PIR-TW-DC or MS04-MW-TW-DC)

**NOTE:** The motion sensor has no dip switch and requires a remote control for programming (**MS04-RC**).

If you require **MS04-RC** instructions, visit [www.csc-led.com](http://www.csc-led.com) to find operation instructions.

