

## WARNINGS



### RISK OF FIRE, ELECTRICAL SHOCK, CUTS OR OTHER CASUALTY HAZARDS

Installation and maintenance of this product must be performed by a qualified electrician. This product must be installed in accordance with the applicable installation code by a person familiar with the construction and operation of the product and hazards involved.

### RISK OF FIRE AND ELECTRIC SHOCK

Make certain power is OFF before starting installation or attempting any maintenance. Disconnect power at fuse or circuit breaker.

### RISK OF FIRE

Refer to product label for specific minimum supply conductor requirements.

### RISK OF BURN

Disconnect power and allow fixture to cool before handling or servicing.

### RISK OF PERSONAL INJURY

Fixture may become damaged and/or unstable if not installed properly.

**DISCLAIMER OF LIABILITY:** CSC LED assumes no liability for damages or losses of any kind that may arise from the improper, careless, or negligent installation, handling or use of this product.

**NOTICE:** Green ground wire provided in proper location. Do not relocate.

**SAFETY:** This fixture must be wired in accordance with the National Electrical Code and applicable local codes and ordinances. Proper grounding is required to insure personal safety. Carefully observe grounding procedure under installation section.

**APPLICATIONS:** This lighting fixture is designed for outdoor lighting services, and should not be used in area of limited ventilation or inside high ambient temperature enclosures. It must be stored in a dry location prior to installation. Do not expose lighting fixture to rain, dust or other environmental conditions prior to installation and insertion of photo control or shorting cap (if so equipped). Best results will be obtained if installed and maintained according to the following recommendations.

**ATTENTION RECEIVING DEPARTMENT:** Note actual fixture description of any shortage or noticeable damage on delivery receipt. File claim for common carrier (LTL) directly with carrier. Claims for concealed damage must be filed within 15 days of delivery. All damaged material, complete with original packing must be retained.

## MOUNTING BRACKET INSTALLATION

The luminaire comes with a ratchet arm and there are 6 optional mounts to choose from (sold separately).

**NOTE:** The ratchet arm needs to be removed for installation of Fixed Mount and Yoke Mount.

## WIRING DIAGRAM

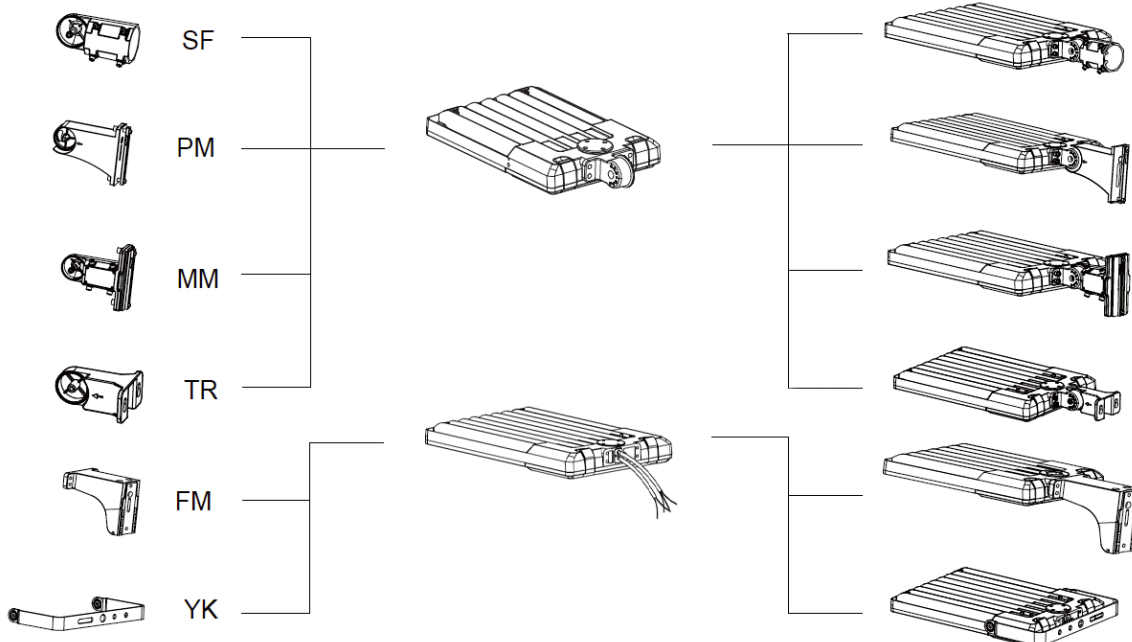
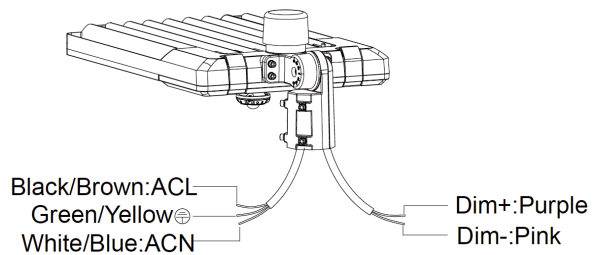

## A. POLE MOUNT INSTALLATION

1. Remove the base of the Pole Mount and use the base as a template for the hole separation. Drill two (2) 10mm holes into the pole and another hole in the middle for the wires.
2. Attach the Pole Mount to the pole using the supplied bracket bar by sliding it into the pole, then secure with the two (2) supplied 8mm Allen bolts. **NOTE:** If the pole is round, you must remove the inner round silicone gasket.
3. Attach the luminaire to the Pole Mount with the supplied 8mm Allen bolt in the centre of the angle adjustment knuckle. The desired angle is set using the same bolt. Angles for this mount can be set between 0° and 35°.
4. Loosen the four (4) Phillips screws of the Pole Mount junction cover and remove the cover.
5. Route the wire leads into the junction and connect the luminaire to the supply wires:
  - a) Connect the supply side line voltage to the black lead.
  - b) Connect the supply side neutral wire to the white lead.
  - c) Connect the supply side ground wire to the green lead.If dimming is needed, connect the purple lead to Dim+ and the pink lead to Dim-. Please cap the dim leads if not in use.
6. Put the Pole Mount junction cover back in place and tighten the four (4) Phillips screws.

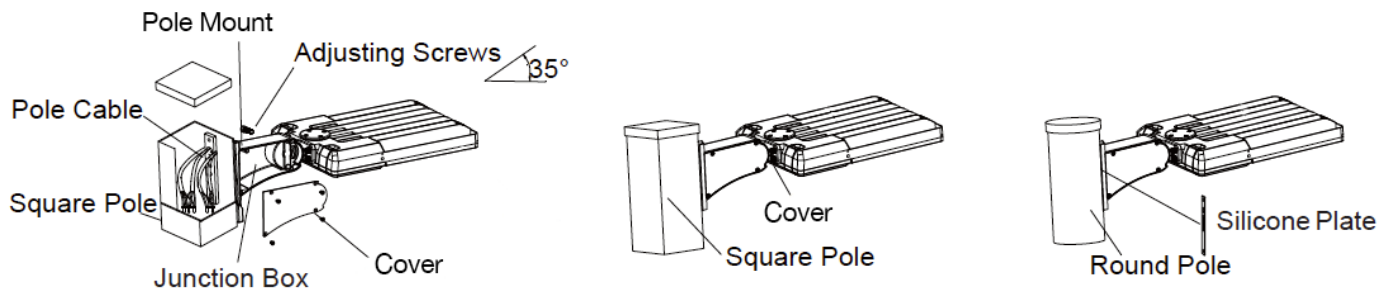

## B. SLIP FITTER INSTALLATION

1. Loosen the four (4) 8mm locking bolts on the Slip Fitter.
2. Route the wire leads through the Slip Fitter and attach the luminaire to the Slip Fitter with the supplied 8mm Allen bolt in the centre of the angle adjustment knuckle. The desired angle is set using the same bolt. Angles for this mount can be set between 0° and 90°.
3. Connect the wires of the luminaire to the supply wires.
  - a) Connect the supply side line voltage to the black lead.
  - b) Connect the supply side neutral wire to the white lead.
  - c) Connect the supply side ground wire to the green lead.If dimming is needed, connect the purple lead to Dim+ and the pink lead to Dim-. Please cap the dim leads if not in use.
4. Slide the mount onto the pole and tighten the four (4) 8mm Allen locking bolts.

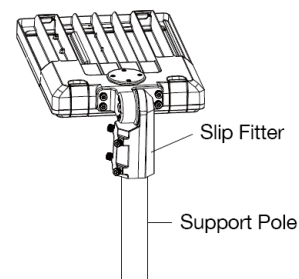
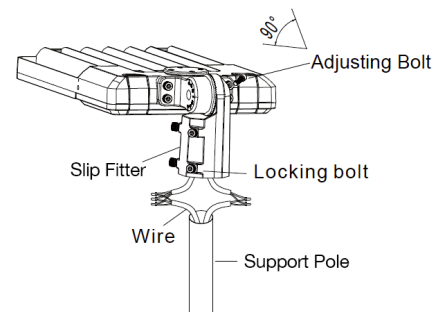

## C. MULTI-MOUNT INSTALLATION AS A POLE MOUNT

1. Remove the bracket bar by loosening the two (2) 8mm Allen bolts. Use the base of the Multi-Mount as a template for the hole separation, drill two (2) 10mm holes and a hole in the middle for the wires.
2. Attach the Multi-Mount to the pole using the supplied bracket bar by sliding it into the pole, then secure with the two (2) supplied 8mm Allen bolts. **NOTE:** If the pole is round, the supplied adapting plate must be used.
3. Attach the luminaire to the Multi-Mount with the supplied 8mm Allen bolt in the centre of the angle adjustment knuckle. The desired angle is set using the same bolt. Angles for this mount can be set between 0° and 90°.
4. Loosen the four (4) Phillips screws of the Multi-Mount junction cover and remove the cover.
5. Route the wire leads into the junction box and connect the luminaire to the supply wires:
  - a) Connect the supply side line voltage to the black lead.
  - b) Connect the supply side neutral wire to the white lead.
  - c) Connect the supply side ground wire to the green lead.If dimming is needed, connect the purple lead to Dim+ and the pink lead to Dim-. Please cap the dim leads if not in use.
6. Put the Multi-Mount junction cover back in place and tighten the four (4) Phillips screws.

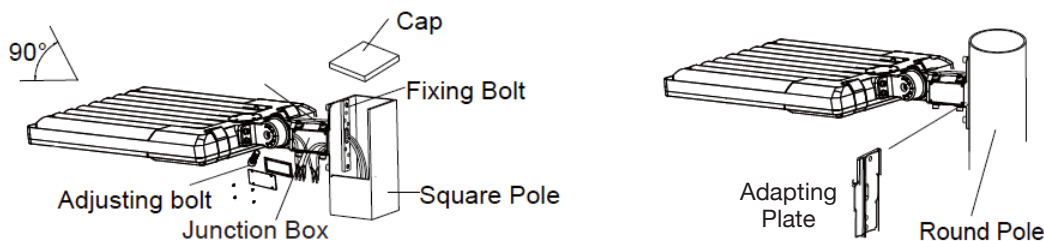

## D. MULTI-MOUNT INSTALLATION AS A SLIP FITTER

1. Remove and discard the entire base plate assembly by loosening the two (2) Allen bolts and the two (2) Phillips screws.
2. Route the wire leads through the Multi-Mount and attach the luminaire to the Multi-Mount with the supplied 8mm Allen bolt in the centre of the angle adjustment knuckle. The desired angle is set using the same bolt. Angles for this mount can be set between 0° and 90°.
3. Connect the luminaire to the supply wires:
  - a) Connect the supply side line voltage to the black lead.
  - b) Connect the supply side neutral wire to the white lead.
  - c) Connect the supply side ground wire to the green lead.If dimming is needed, connect the purple lead to Dim+ and the pink lead to Dim-. Please cap the dim leads if not in use.
4. Attach the mount onto the pole and tighten the four (4) included 8mm Allen bolts.

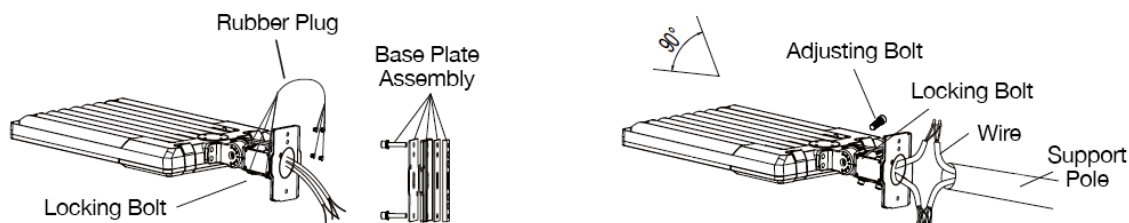

## E. TRUNNION MOUNT INSTALLATION

1. Using the base of the Trunnion Mount as a template for the hole separation, drill two (2) 10mm holes into the surface that the luminaire is being attached to.
2. Route the wire leads through the Trunnion Mount and attach the luminaire to the Trunnion Mount with the supplied 8mm Allen bolt in the centre of the angle adjustment knuckle. The desired angle is set using the same bolt. Angles for this mount can be set between 0° and 90°.
3. Slide the supplied M8x60 expanding bolts through the Trunnion Mounting holes and into the pre-drilled holes and tighten until fully secured.
4. Connect the luminaire to the supply wires:
  - a) Connect the supply side line voltage to the black lead.
  - b) Connect the supply side neutral wire to the white lead.
  - c) Connect the supply side ground wire to the green lead.If dimming is needed, connect the purple lead to Dim+ and the pink lead to Dim-. Please cap the dim leads if not in use.

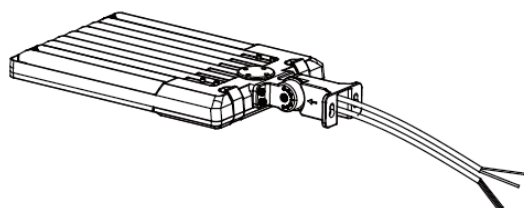
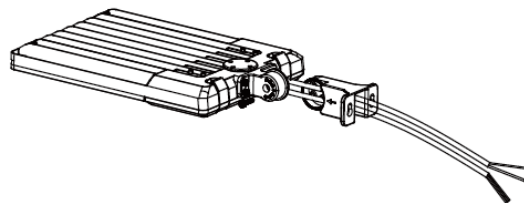

## F. FIXED MOUNT INSTALLATION

1. Drill two (2) 10mm holes into the surface that the luminaire is being attached to.
2. Slide Part B out of the fixed mount assembly and affix it to the pole with two (2) 8mm Allen bolts.  
**NOTE:** If the pole is round, you must remove the inner round silicone gasket. (Fig. 1 and Fig. 2)
3. Remove and discard the ratchet arm by loosening the two (2) 8mm bolts that connect the mount to the bottom of the luminaire.
4. Route the wire leads through the Fixed Mount Part A and attach the luminaire to the Mount with the four (4) 8mm Allen bolts. (Fig. 3)
5. Connect the luminaire to the supply wires:
  - a) Connect the supply side line voltage to the black lead.
  - b) Connect the supply side neutral wire to the white lead.
  - c) Connect the supply side ground wire to the green lead.If dimming is needed, connect the purple lead to Dim+ and the pink lead to Dim-. Please cap the dim leads if not in use.
6. Insert Part A into Part B and lock with two (2) 8mm Allen bolts. Close the arm cover. (Fig. 4)

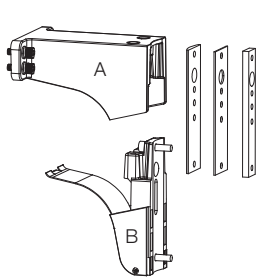

Fig. 1

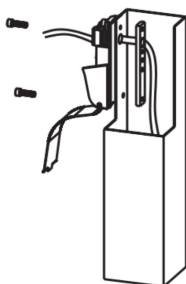

Fig. 2

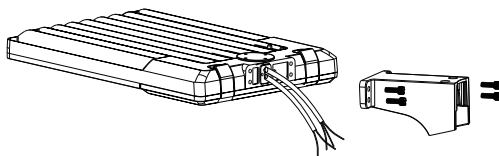

Fig. 3

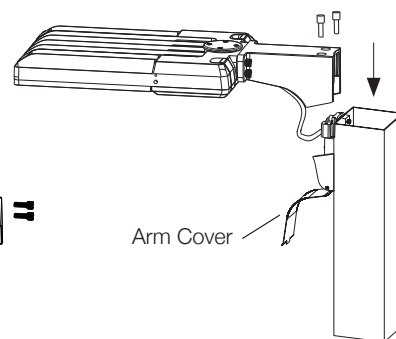
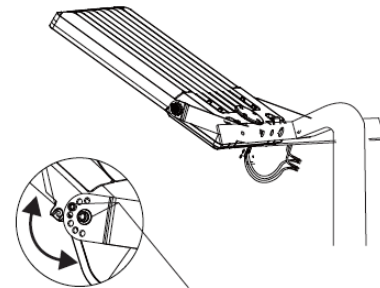
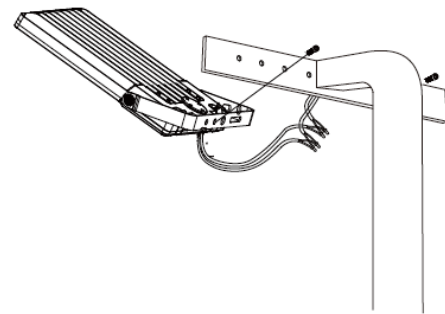

Fig. 4

## G. YOKE MOUNT INSTALLATION

1. Remove and discard the ratchet arm by loosening the two (2) 8mm bolts that connect the mount to the bottom of the luminaire.
2. Using the base of the Yoke Mount as a template for the hole separation, drill at least two holes into the surface that the luminaire is being attached to (hardware not included).
3. Attach the luminaire to the Yoke Mount using the supplied 8mm Allen bolts on the centering holes, and the 4mm Allen bolts on the angle adjustment holes located on the side of the luminaire. The angle adjustment bolt is also used to set the desired luminaire angle.
4. Attach the Yoke Mount to the installation surface using appropriate customer-supplied hardware.
5. Connect the luminaire to the supply wires:
  - a) Connect the supply side line voltage to the black lead.
  - b) Connect the supply side neutral wire to the white lead.
  - c) Connect the supply side ground wire to the green lead.
 If dimming is needed, connect the purple lead to Dim+ and the pink lead to Dim-. Please cap the dim leads if not in use.



Loosen the angle to adjust the screw, after adjust to the angle that you need, then tighten the screws.

## PHOTOCELL INSTALLATION

The photocell (JL-205LV or JL-207E) is installed on the back of the luminaire. When the photocell function is not required, the photocell can be removed but a shorting cap (JL-208) will need to be installed.

**NOTE:** The receptacle (JL-200), photocell (JL-205LV or JL-207E) and shorting cap (JL-208) are sold separately.

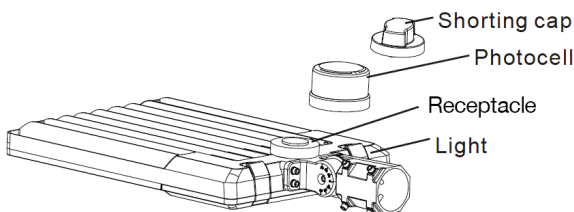

## MOTION SENSOR INSTALLATION

Using a screwdriver, unscrew the 1/2" knockout and screw on the motion sensor (MS01-PIR-TW-DC or HB01DMS-A). **NOTE:** The motion sensor has no dip switch and requires a remote control for programming (HB01R). If you require HB01R instructions, visit [www.csc-led.com](http://www.csc-led.com) to find operating instructions.

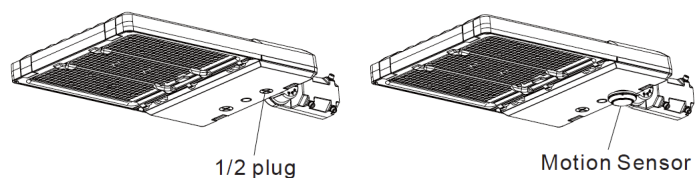

## WATTAGE AND CCT SELECTION

Using a screwdriver, unscrew the 1/2" knockout. Select your desired wattage and colour temperature using the CCT and wattage selectable switch.

