

Trade Mark:  
CRYSTAL WORLD INC

Product Name: Pendant lamp  
Model :5443P14C  
120Vac, 60Hz,AC ONLY  
Lamp Size:Ø14"X48"H

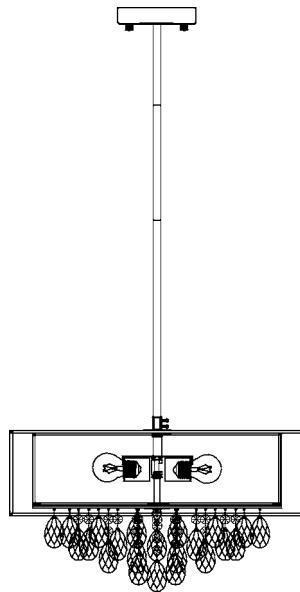

## PENDANT LAMP ASSEMBLY INSTRUCTIONS

1. Place fixture(A) onto mounting screws (DD), secure with cap nuts (AA). Please fix (A) with (B). (B) with (C), (C) with (D).

### Hardware Used



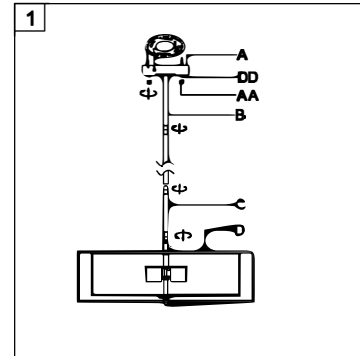

- AA Cap nut  X 2
- DD Mounting screw  X2

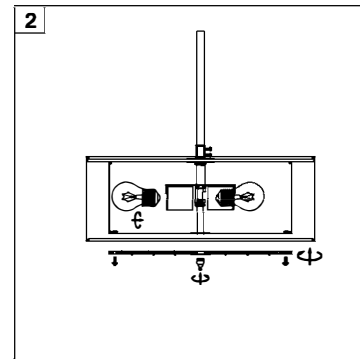

2. Light bulbs (not included).  
**120V E26 3\*60W Max.**



3. Please hang the crystal (1) (2) (3) (4) to the fixture.

- |   |   |   |   |
|---|---|---|---|
| 1   | 2   | 3   | 4   |
|  |  |  |  |
| 50mm*1PCS   | 14mm*1PCS   | 14mm*2PCS   | 14mm*2PCS   |
| 12PCS   | 50mm*1PCS   | 50mm*1PCS   | 50mm*1PCS   |
|   | 8PCS  | 5PCS  |   |

