

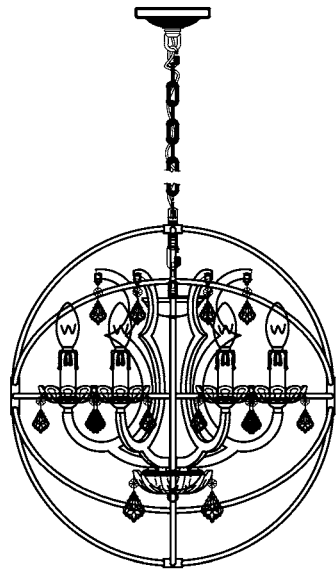

Trade Mark:
CRYSTAL WORLD INC







Product Name: Pendant lamp
Model :5465P22DB
120Vac, 60Hz,AC ONLY
Lamp Size:Ø22"X23"H

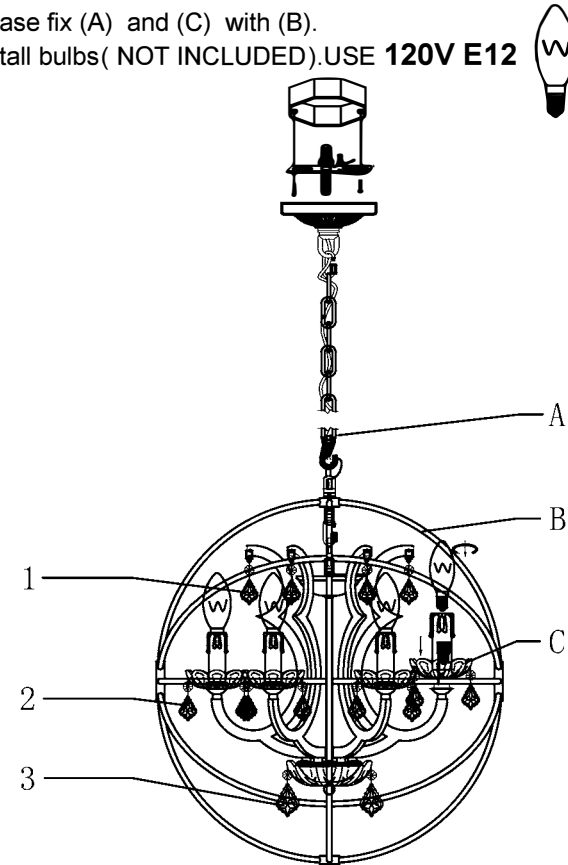

PENDANT LAMP ASSEMBLY INSTRUCTIONS

1. Please fix (A) and (C) with (B).
2. Install bulbs (NOT INCLUDED). USE **120V E12**  **6*40W Max.**



1	2	3	C
			
14mm*1PCS	14mm*1PCS	14mm*1PCS	Ø100mm*1PCS
			
38mm*1PCS	38mm*1PCS	50mm*1PCS	
6PCS	24PCS	6PCS	6PCS