

Trade Mark:
CRYSTAL WORLD INC

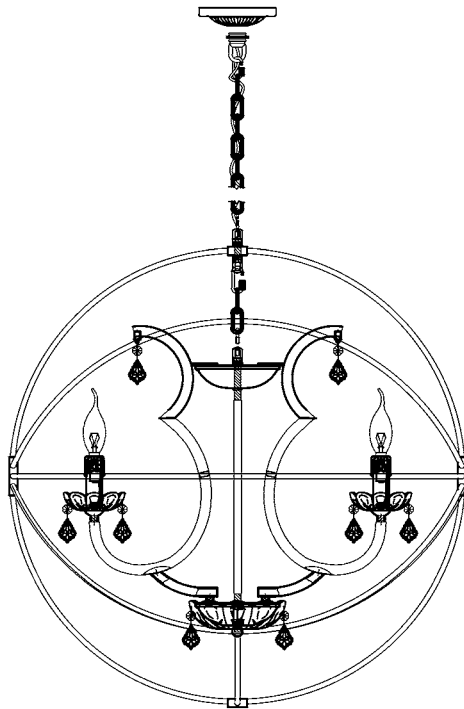





Product Name: Pendant lamp
Model :5465P28DB
120Vac, 60Hz,AC ONLY
Lamp Size:Ø28"X29"H

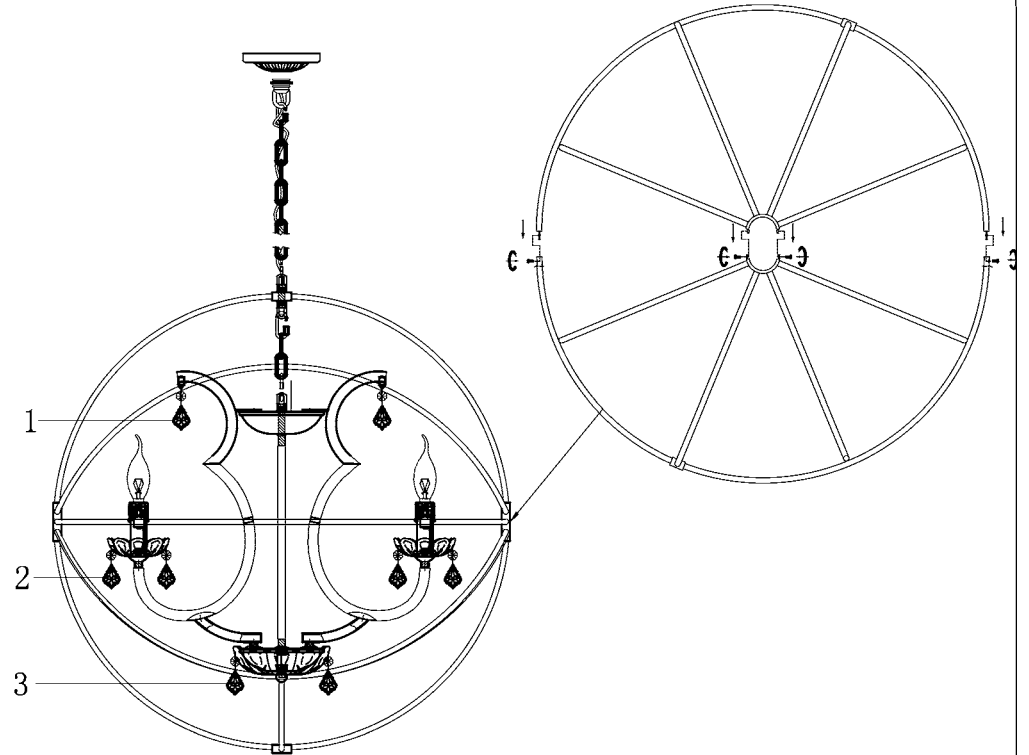

PENDANT LAMP ASSEMBLY INSTRUCTIONS

1.Install bulbs(NOT INCLUDED).USE 120V E12  8*40W Max.



- | | | |
|--|--|--|
| 1 | 2 | 3 |
| 
14mm*1PCS | 
14mm*1PCS | 
14mm*1PCS |
| 
38mm*1PCS | 
38mm*1PCS | 
38mm*1PCS |

NO.	1	2	3
Quantity	8	32	8