

Trade Mark:
CRYSTAL WORLD INC

Product Name: Ceiling lamp
Model :5644C22ST-R
120Vac, 60Hz,AC ONLY
Lamp size:Ø22"XH11"

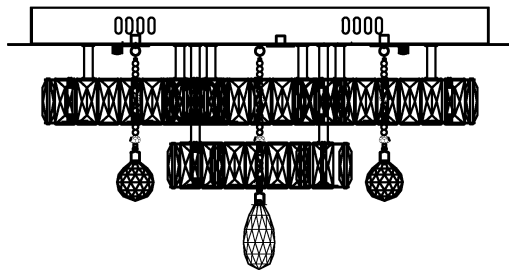

CEILING LAMP ASSEMBLY INSTRUCTIONS



1. Place fixture(A) onto mounting screws (DD).secure with cap nuts (AA).

Hardware Used

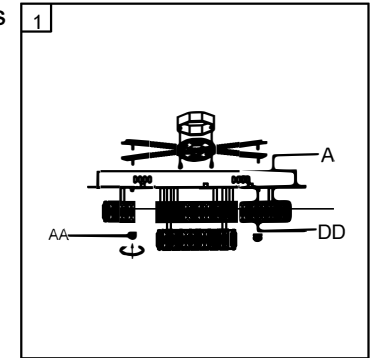
AA Cap nut  X 4
DD Mounting screw  X 4



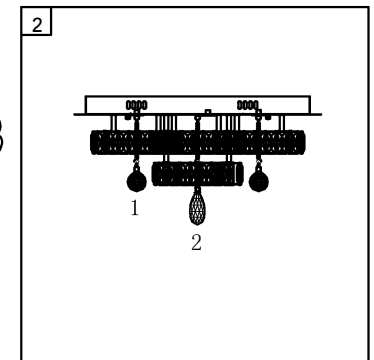

2. Please put the crystal (1) (2) to the fixture (A) .

1  $\phi 6\text{mm} \times 12\text{pcs}$
 $\phi 12\text{mm} \times 2\text{pcs}$
 $\phi 4.0\text{mm} \times 1\text{pcs}$
10PCS
2  $\phi 6\text{mm} \times 18\text{pcs}$
 $\phi 12\text{mm} \times 3\text{pcs}$
 $\phi 35 \times 76\text{mm} \times 1\text{pcs}$
1PCS



3. lighting bulbs (not included).

120V LED  21*1W+
120V LED  6*3W
DIMMABLE (4000K)

