

Trade Mark:
CRYSTAL WORLD INC

Product Name: Pendant lamp
Model :6640P32C-O
120Vac, 60Hz,AC ONLY
Lamp Size:L32**W9**48"H

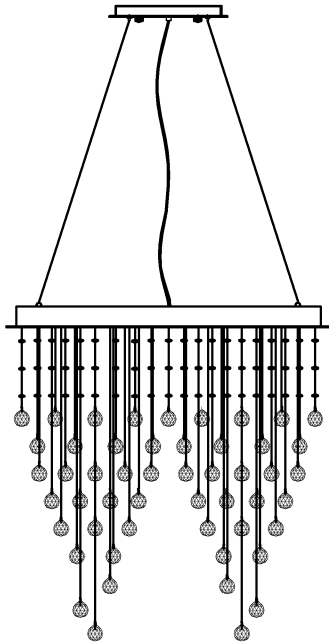

PENDANT LAMP ASSEMBLY INSTRUCTIONS

1.Place fixture(A)onto mounting screws (DD),secure with cap nuts (AA).

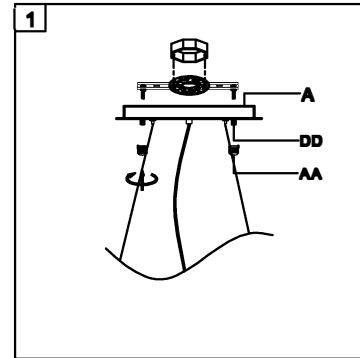

Hardware Used

AA Cap nut  X 2
DD Mounting screw  X 2

2.Please hang the crystal (1) to the fixture .

1
 40mm*1PCS
87PCS

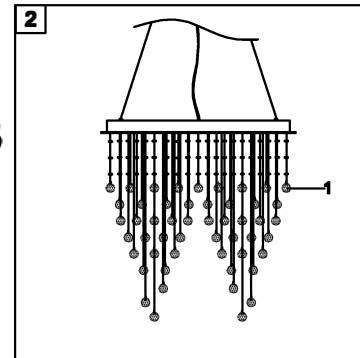

3.Install light bulbs (not included).

Use bulb
120V Gu10  6*35W Max.

