

Trade Mark:
CRYSTAL WORLD INC

Product Name: Ceiling lamp
Model :8001C14
120Vac, 60Hz,AC ONLY
Lamp size:ø14"XH9"

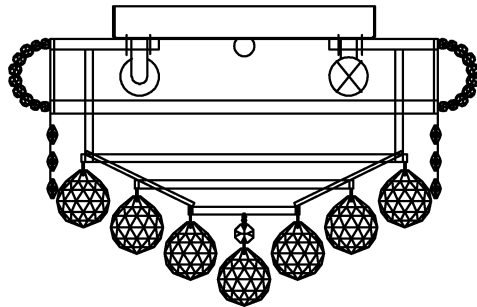

CEILING LAMP ASSEMBLY INSTRUCTIONS



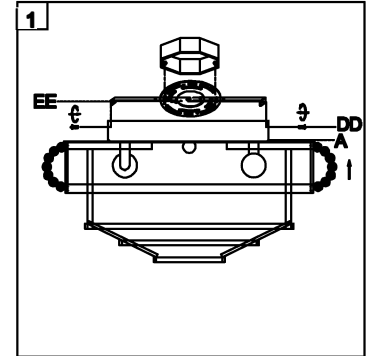

1. Place fixture (A) onto Crossbar (EE).
secure with Mounting screw (DD).

Hardware Used

DD Mounting screw  X 2



2. Please put the crystal (1) (2) (3) to the
fixture (A) .

1	2	3	
			
14mm*3pcs	40mm*1pcs	14mm*1pcs 40mm*1pcs	
57PCS	36PCS	1PCS	

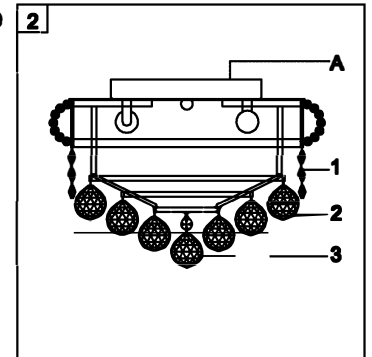

3. Install light bulbs (not included).
Use bulb  4*40W Max.

