

Trade Mark:
CRYSTAL WORLD INC

Product Name: Ceiling lamp
Model :8005C12C-R
120Vac, 60Hz,AC ONLY
Lamp size:Ø12"XH6"

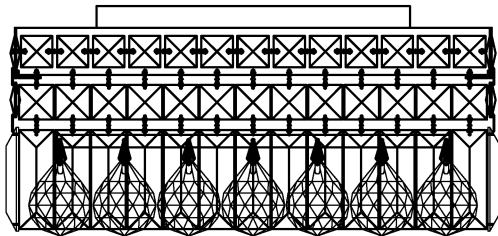

CEILING LAMP ASSEMBLY INSTRUCTIONS

1. Place fixture(A) onto mounting screws (DD). secure with cap nuts (AA).

Hardware Used

AA Cap nut  X 4
DD Mounting screw  X 4

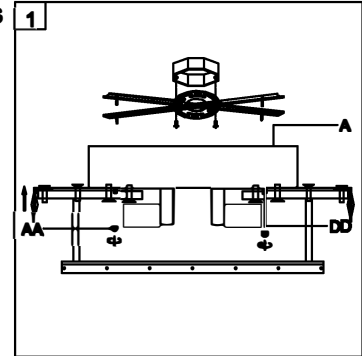

2. Please put the crystal (1) (2) to the fixture .

1  22mm*1PCS
63mm*1PCS
44pcs

2  40mm*1PCS
37pcs

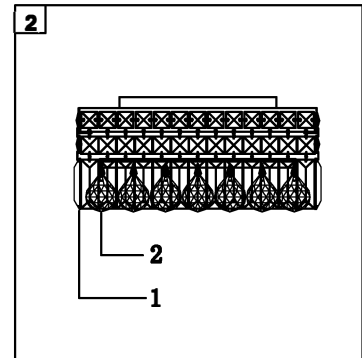
3. Install light bulbs (not included).
Use bulb
120V E12  4*40W Max.

