

CWI LIGHTING

BRIGHTER LIVING. SIMPLIFIED.

PROJECT: _____
 FIXTURE TYPE: _____
 LOCATION: _____
 CONTACT/PHONE: _____

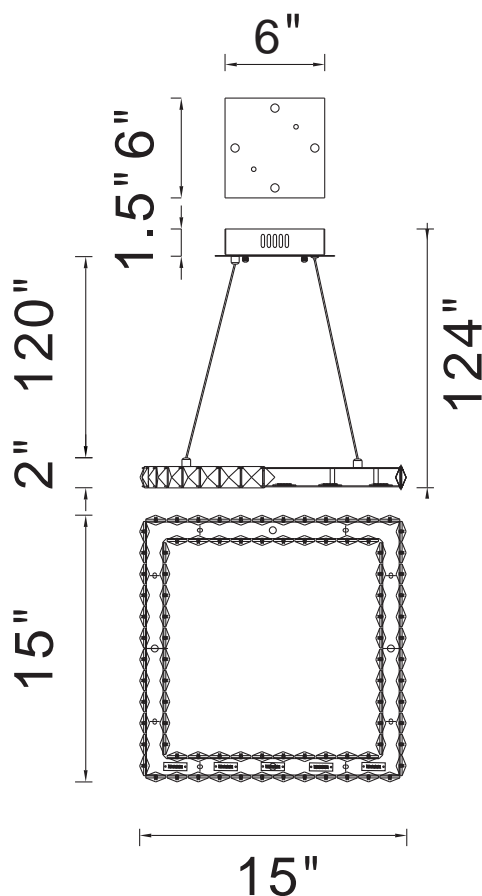

Item	5080P15ST-S
Collection	RING
Finish	Stainless Steel
Glass	-----
Crystal	Clear
Input	120V AC,60HZ,AC

Shade	-----
Length/Dia.	15"
Width/Ext.	15"
Height	2"
Maximum	124"
Lumens	1020

Light Source	LED
Bulb Info.	20W
Included	-----
Dimmable	No
Color	4000K
Weight	

CWILIGHTING
www.cwilighting.com
Info@cwilighting.com

140 Steelcase Rd.W.
 Markham ON. L3R 3J9 Canada
 Tel: 905 940 4999
 Toll: 1-877-564-6034
 Fax: 905-940-0126
 Toll Fax: 1-866-840-2796

Dallas showroom
 Dallas Market Center
 Showroom #: 3327
 2100N. Stemmons Frwy.
 Dallas, TX 75207

