



PROJECT: \_\_\_\_\_

FIXTURE TYPE: \_\_\_\_\_

LOCATION: \_\_\_\_\_

CONTACT/PHONE: \_\_\_\_\_

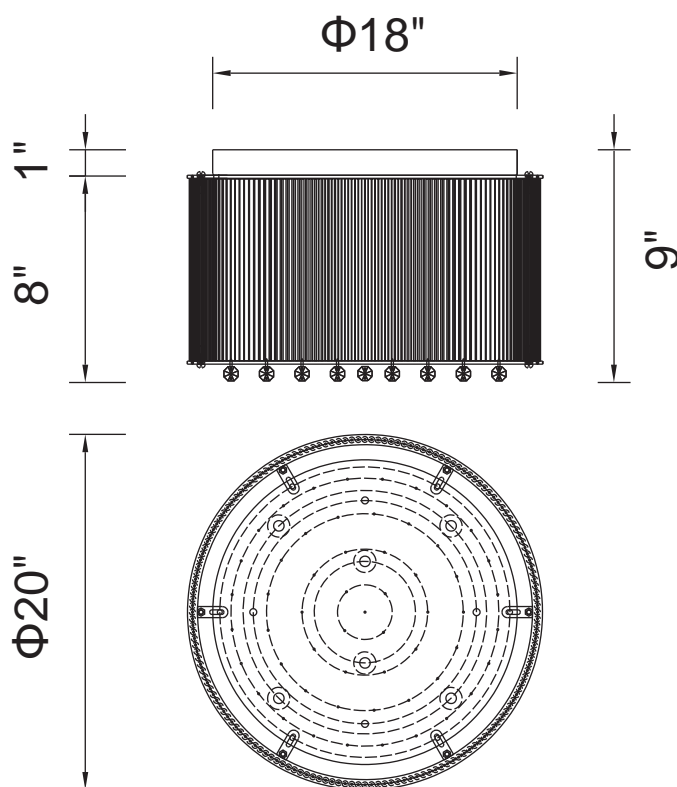

Item	5319C20C-R
Collection	SPRING MORNING
Finish	Chrome
Glass	Clear
Crystal	Clear
Input	120V AC,60HZ,AC

Shade	-----
Length/Dia.	20"
Width/Ext.	-----
Height	9"
Maximum	-----
Lumens	-----

Light Source	G9
Bulb Info.	9x40W
Included	-----
Dimmable	Yes
Color	-----
Weight	-----