

# CWI LIGHTING

BRIGHTER LIVING. SIMPLIFIED.

PROJECT: \_\_\_\_\_

FIXTURE TYPE: \_\_\_\_\_

LOCATION: \_\_\_\_\_

CONTACT/PHONE: \_\_\_\_\_

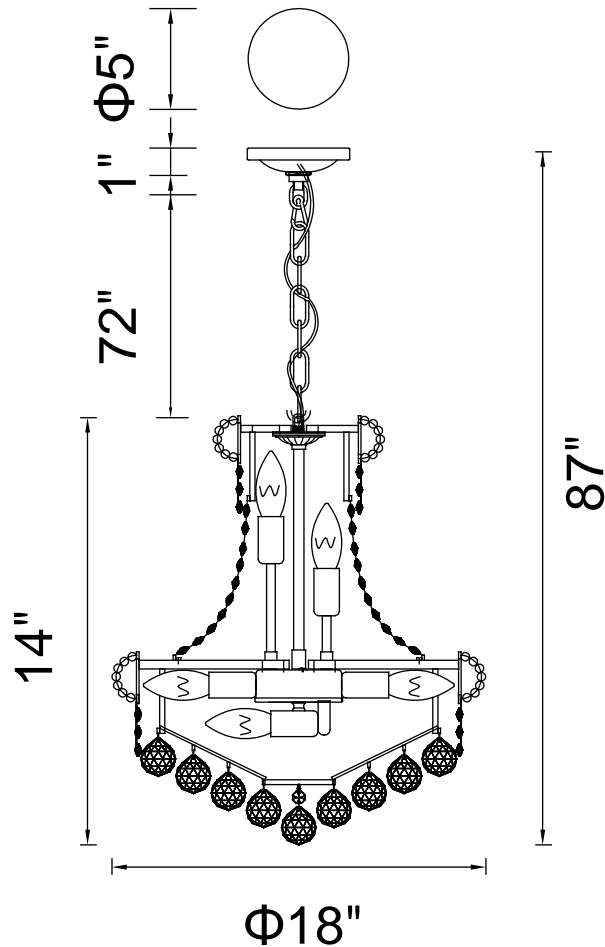

Item	8001P14G
Collection	EMPIRE
Finish	Gold
Glass	-----
Crystal	Clear
Input	120V AC,60HZ,AC

Shade	-----
Length/Dia.	18"
Width/Ext.	-----
Height	14"
Maximum	87"
Lumens	-----

Light Source	E12
Bulb Info.	6x60W
Included	-----
Dimmable	No
Color	-----
Weight	