

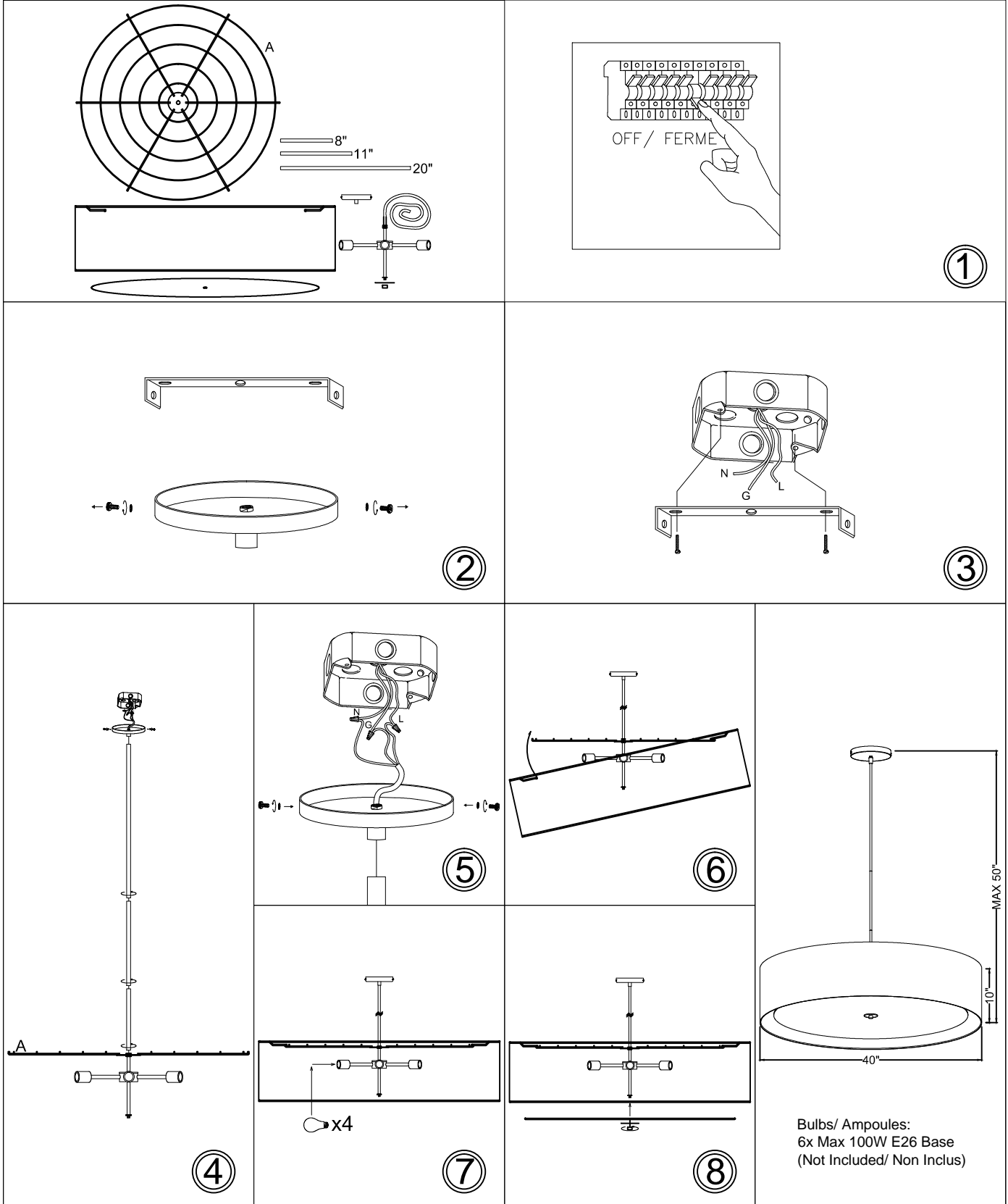

# HEL-406P-PC



1401 Courtney Park Drive East, Mississauga, Ontario, Canada L5T 2E4  
Tel: (905) 564-1262 Fax: (905) 564-1299 Email: [dainolite@dainolite.ca](mailto:dainolite@dainolite.ca) Web: [www.dainolite.ca](http://www.dainolite.ca)

12/2020