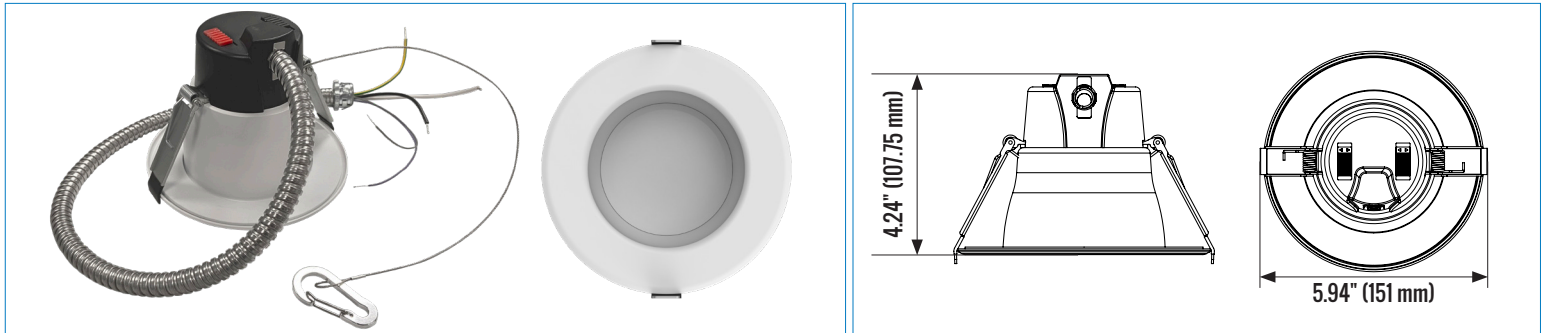

PRODUCT CODE: DLCLR4-5812WCO-WH-FB
4 INCH LED COMMERCIAL RECESSED DOWNLIGHT / MULTI-WATTAGE / 3CCT

PRODUCT DESCRIPTION

The new Etlin-Daniels DLCLR4-5812WCO-WH-FB LED Commercial Recessed Downlight offers a simple to install, high performance solution for a wide variety of applications. Each LED fixture is available in 120-347V, and has a 3CCT switch offering 3000K, 3500K & 4000K options, along with a Multi-Wattage Switch offering 3 lumen / wattage levels.

The deep baffle design provides glare free illumination with a 90° beam pattern. Wet location rated, with an IC Rated, Airtight Housing, the new DLCLR series is the perfect option for either new design builds, or to retrofit and upgrade existing recessed housings.

Available in a white housing with snap-on black and silver trims. White goof rings and pre-mounting plates are available for T-Grid ceilings as well as stud / joist installations. The 3 sizes provide the perfect solution for retail, commercial and residential, hospitality, educational and healthcare applications. For further energy savings, take advantage of the 0-10V Continuous Dimming.

FEATURES

- LED Indoor Light Source
- Wet Location Rated
- IC Rated with Airtight Housing
- 90 CRI
- 120-347V
- 90° Beam Pattern
- 3CCT and 3 Multi-Wattage Switching
- 0-10V Continuous Dimming
- Snap-On Black and Silver Trims
- Goof Rings (white) Available
- 24" BX Cable Attached with Connector
- Safety Clip Attached
- 5 Year Warranty
- Energy Star Certified

PRODUCT SPECIFICATIONS (OPTICAL DATA)

LED TYPE	LED QTY	MULTI-WATTAGE / LUMENS / SELETABLE COLOR TEMPERATURE	SYSTEM EFFICACY	BEAM ANGLE	CRI	SYSTEM EFFICIENCY	POWER EFFICIENCY	POWER FACTOR	HARMONIC DISTORTION
HONGLI 2835	52CHIPS	5.5W - 3000K - 499LM / 3500K - 495LM / 4000K - 494LM 8W - 3000K - 735LM / 3500K - 760LM / 4000K - 750LM 12W - 3000K - 1059LM / 3500K - 1103LM / 4000K - 1054LM	91 LM/W 87.5 LM/W 83.3 LM/W	90°	>90CRI	>0.80%	>80%	>0.90	25%

PRODUCT SPECIFICATIONS

VOLTAGE	POWER FREQ.	FIXTURE MATERIAL	LIFE SPAN	STORAGE TEMP	OPERATING TEMP	PRODUCT DIMENSIONS	CARTON SIZE	
120 - 347V	50/60HZ	ALUMINUM/ POLYCARBONATE LENS	>50,000 HOURS	- 20° C ~ -40° C - 4° F ~ -104° F	- 20° C ~ -40° C - 4° F ~ -104° F	Ø5.94 X 4.24 INCHES (151 X 108 MM)	4.84 X 4.92 X 6.14 INCHES (123 X 125 X 156MM)	

ADDITIONAL INFORMATION

INSTALLATION METHOD

RECESSED CEILING MOUNT

FIXTURE COLOR

WHITE WITH FROSTED LENS

CONTROL TYPE

0 - 10V CONTINUOUS DIMMING

PRODUCT CODE: DLCLR4-5812WCO-WH-FB
4 INCH LED COMMERCIAL RECESSED DOWNLIGHT /MULTI-WATTAGE/3CCT

LUMINAIRE PHOTOMETRIC (TEST REPORT) - 5.5W - 3000K
ILLUMINANCE (AT A DISTANCE) - FLUX OUT: 114.9 LM

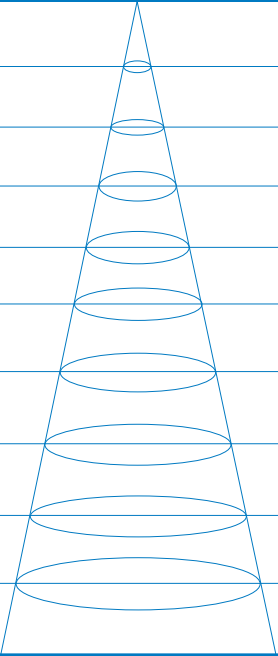
3.28FT 1M	36.57, 64.17LX		6.56FT 200.00CM
6.56FT 2M	9.143, 16.04LX		13.12FT 400.00CM
9.84FT 3M	4.064, 7.130LX		19.69FT 600.00CM
13.12FT 4M	2.286, 4.010LX		26.24FT 800.00CM
16.40FT 5M	1.463, 2.567LX		32.80FT 1000.00CM
19.69FT 6M	1.016, 1.782LX		39.37FT 1200.00CM
22.97FT 7M	0.7464, 1.310LX		45.93FT 1400.00CM
26.25FT 8M	0.5714, 1.003LX		52.49FT 1600.00CM
29.52FT 9M	0.4515, 0.7922LX		59.05FT 1800.00CM
32.80FT 10M	0.3657, 0.6417LX		65.61FT 2000.00CM
HT	EAVG/EMAX	ANGLE: 90.00DEG	DIA

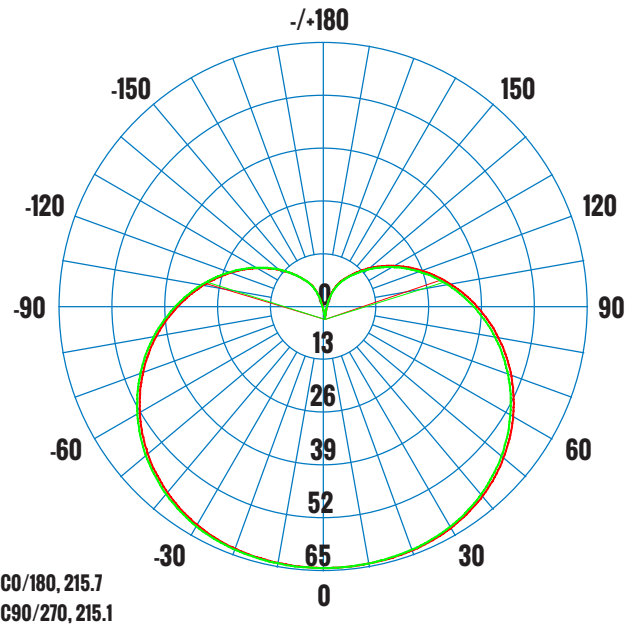
LUMINOUS INTENSITY DISTRIBUTION DIAGRAM

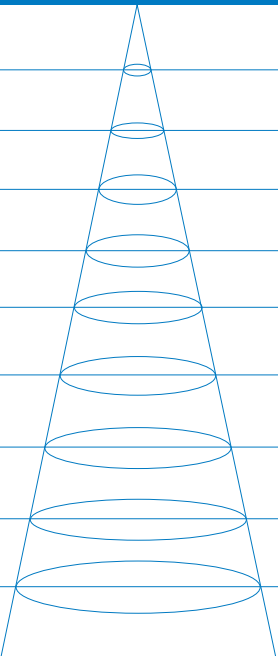
AVERAGE BEAM ANGLE(50%) - 215.4 DEG
LUMINAIRE PHOTOMETRIC (TEST REPORT) - 5.5W - 3500K
ILLUMINANCE (AT A DISTANCE) - FLUX OUT: 316.8LM

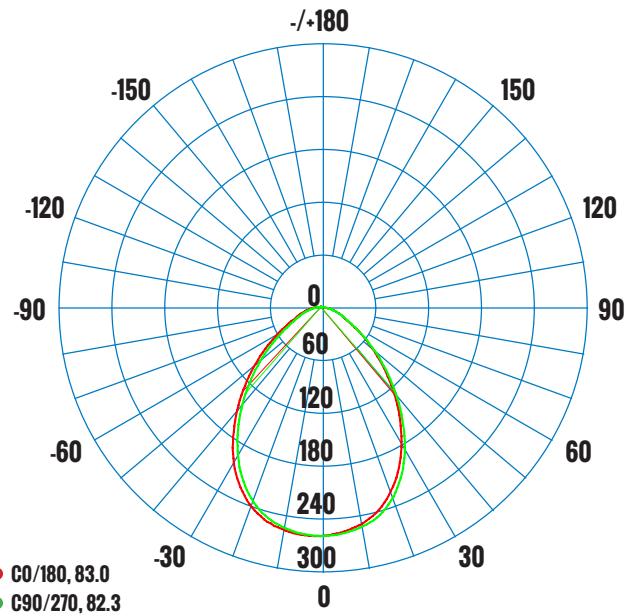
3.28FT 1M	124.4, 263.2LX		5.708FT 173.99CM
6.56FT 2M	31.09, 65.79LX		11.416FT 347.99CM
9.84FT 3M	13.82, 29.24LX		17.125FT 521.98CM
13.12FT 4M	7.773, 16.45LX		22.83FT 695.97CM
16.40FT 5M	4.975, 10.53LX		28.54FT 869.96CM
19.69FT 6M	3.455, 7.310LX		34.25FT 1043.96CM
22.97FT 7M	2.538, 5.370LX		39.95FT 1217.95CM
26.25FT 8M	1.943, 4.112LX		45.67FT 1391.94CM
29.52FT 9M	1.535, 3.249LX		51.37FT 1565.94CM
32.80FT 10M	1.244, 2.632LX		57.08FT 1739.93CM
HT	EAVG/EMAX	ANGLE: 82.04DEG	DIA

LUMINOUS INTENSITY DISTRIBUTION DIAGRAM

AVERAGE BEAM ANGLE(50%) - 82.5 DEG

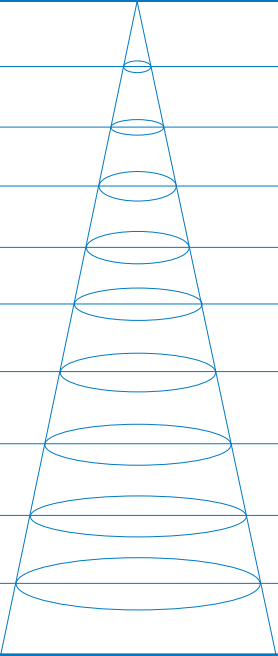
PRODUCT CODE: DLCLR4-5812WCO-WH-FB
4 INCH LED COMMERCIAL RECESSED DOWNLIGHT /MULTI-WATTAGE/3CCT

LUMINAIRE PHOTOMETRIC (TEST REPORT) - 5.5W - 4000K
ILLUMINANCE (AT A DISTANCE) - FLUX OUT: 316.1 LM

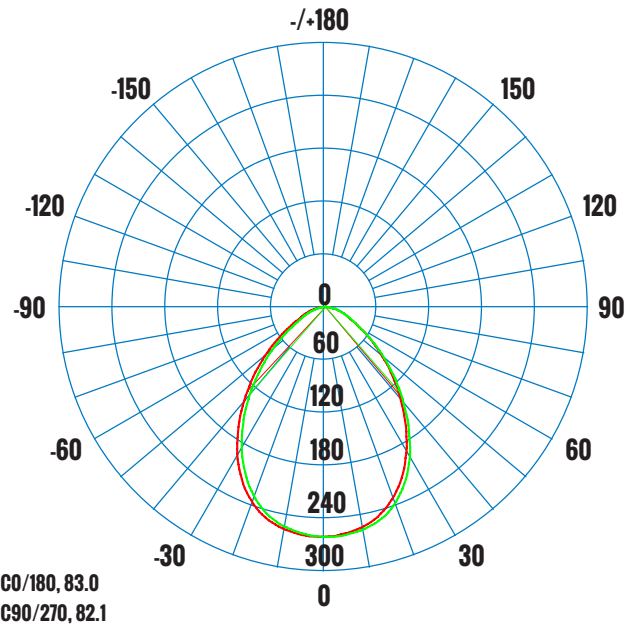
3.28FT 1M	36.57, 64.17LX		5.717FT 174.05CM
6.56FT 2M	9.143, 16.04LX		11.42FT 348.11CM
9.84FT 3M	4.064, 7.130LX		17.13FT 522.16CM
13.12FT 4M	2.286, 4.010LX		22.84FT 696.22CM
16.40FT 5M	1.463, 2.567LX		28.55FT 870.27CM
19.69FT 6M	1.016, 1.782LX		34.26FT 1044.32CM
22.97FT 7M	0.7464, 1.310LX		39.97FT 1218.38CM
26.25FT 8M	0.5714, 1.003LX		45.68FT 1392.43CM
29.52FT 9M	0.4515, 0.7922LX		51.39FT 1566.49CM
32.80FT 10M	0.3657, 0.6417LX		57.10FT 1740.54CM
HT	EAVG/EMAX	ANGLE: 90.00DEG	DIA

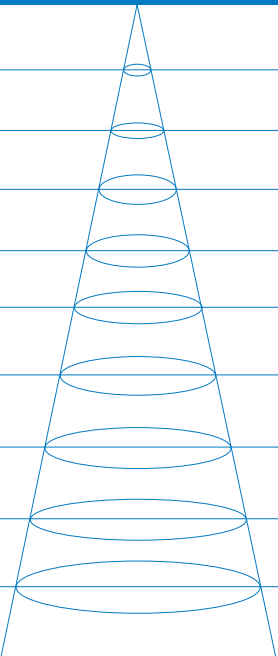
LUMINOUS INTENSITY DISTRIBUTION DIAGRAM

AVERAGE BEAM ANGLE(50%) - 82.5 DEG
LUMINAIRE PHOTOMETRIC (TEST REPORT) - 8W - 3000K
ILLUMINANCE (AT A DISTANCE) - FLUX OUT: 470.4LM

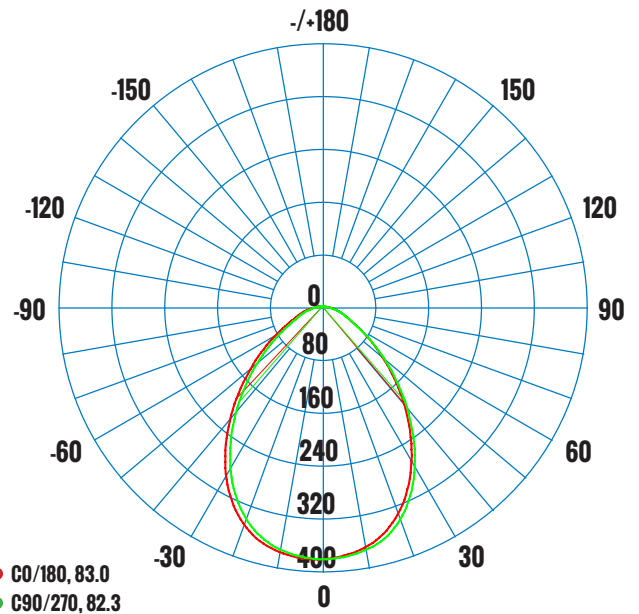
3.28FT 1M	184.7, 391.0LX		5.710FT 174.05CM
6.56FT 2M	46.18, 97.74LX		11.42FT 348.11CM
9.84FT 3M	20.52, 43.44LX		17.13FT 522.16CM
13.12FT 4M	11.54, 24.44LX		22.84FT 696.22CM
16.40FT 5M	7.388, 15.64LX		28.55FT 870.27CM
19.69FT 6M	5.131, 10.86LX		34.26FT 1044.32CM
22.97FT 7M	3.769, 7.979LX		39.97FT 1218.38CM
26.25FT 8M	2.886, 6.109LX		45.68FT 1392.43CM
29.52FT 9M	2.280, 4.827LX		51.39FT 1566.49CM
32.80FT 10M	1.847, 3.910LX		57.10FT 1740.54CM
HT	EAVG/EMAX	ANGLE: 82.06DEG	DIA

LUMINOUS INTENSITY DISTRIBUTION DIAGRAM

AVERAGE BEAM ANGLE(50%) - 82.5 DEG

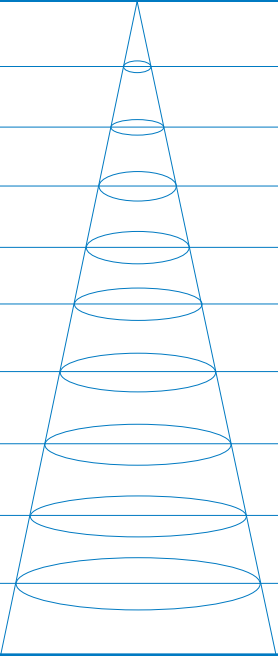
PRODUCT CODE: DLCLR4-5812WCO-WH-FB
4 INCH LED COMMERCIAL RECESSED DOWNLIGHT /MULTI-WATTAGE/3CCT

LUMINAIRE PHOTOMETRIC (TEST REPORT) - 8W - 3500K
ILLUMINANCE (AT A DISTANCE) - FLUX OUT: 486.4 LM

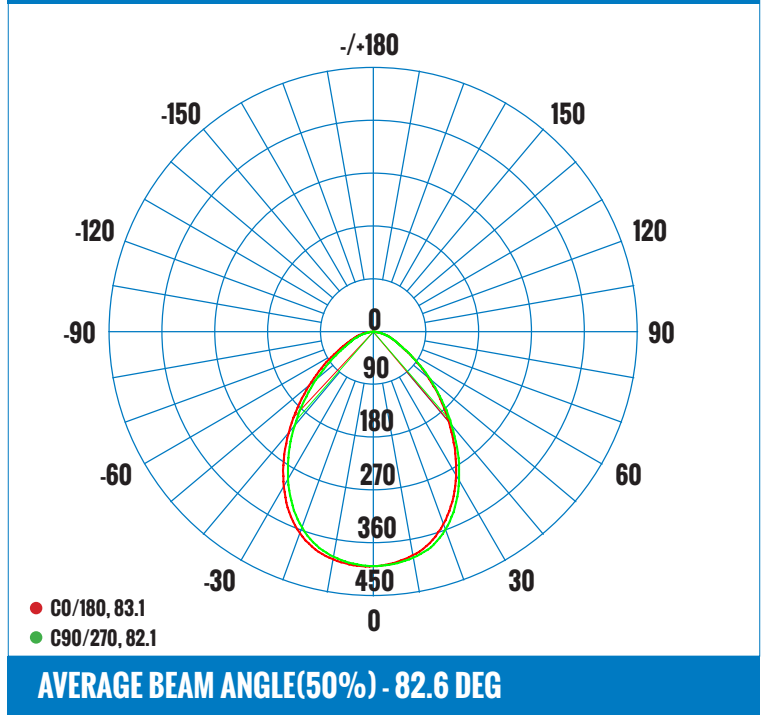
3.28FT 1M	191.0, 404.0LX		5.717FT 174.24CM
6.56FT 2M	47.74, 101.01LX		11.43FT 348.48CM
9.84FT 3M	21.22, 44.89LX		17.15FT 522.71CM
13.12FT 4M	11.94, 25.25LX		22.86FT 696.95CM
16.40FT 5M	7.639, 16.16LX		28.58FT 871.19CM
19.69FT 6M	5.305, 11.22LX		34.29FT 1045.43CM
22.97FT 7M	3.898, 8.245LX		40.01FT 1219.67CM
26.25FT 8M	2.984, 6.313LX		45.73FT 1393.91CM
29.52FT 9M	2.358, 4.988LX		51.44FT 1568.14CM
32.80FT 10M	1.910, 4.040LX		57.16FT 1742.38CM
HT	EAVG/EMAX	ANGLE: 82.12DEG	DIA

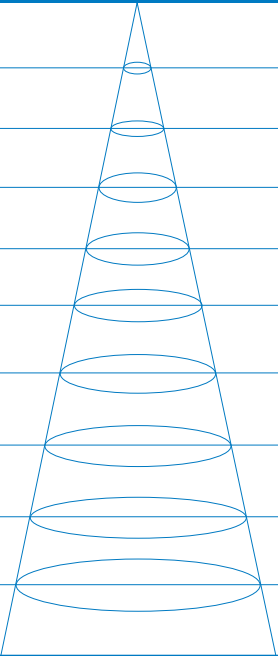
LUMINOUS INTENSITY DISTRIBUTION DIAGRAM

LUMINAIRE PHOTOMETRIC (TEST REPORT) - 8W - 4000K
ILLUMINANCE (AT A DISTANCE) - FLUX OUT: 479.6LM

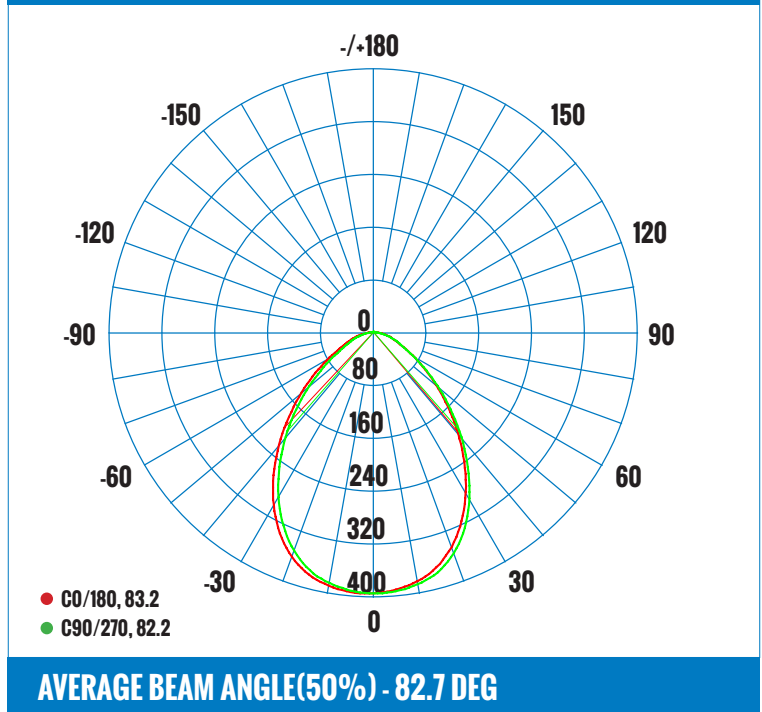
3.28FT 1M	188.3, 398.0LX		5.721FT 174.39CM
6.56FT 2M	47.08, 99.50LX		11.444FT 348.78CM
9.84FT 3M	20.92, 44.22LX		17.16FT 523.17CM
13.12FT 4M	11.77, 24.88LX		22.89FT 697.57CM
16.40FT 5M	7.532, 15.92LX		28.61FT 871.96CM
19.69FT 6M	5.231, 11.06LX		34.32FT 1046.35CM
22.97FT 7M	3.843, 8.122LX		40.05FT 1220.74CM
26.25FT 8M	2.942, 6.219LX		45.77FT 1395.13CM
29.52FT 9M	2.325, 4.914LX		51.49FT 1569.52CM
32.80FT 10M	1.883, 3.980LX		57.21FT 1743.92CM
HT	EAVG/EMAX	ANGLE: 82.17DEG	DIA

LUMINOUS INTENSITY DISTRIBUTION DIAGRAM

PRODUCT CODE: DLCLR4-5812WCO-WH-FB
4 INCH LED COMMERCIAL RECESSED DOWNLIGHT /MULTI-WATTAGE/3CCT

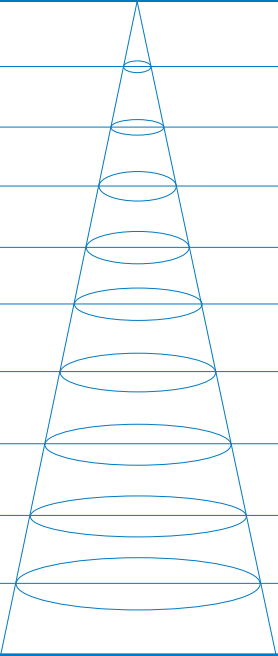
LUMINAIRE PHOTOMETRIC (TEST REPORT) - 12W - 3000K
ILLUMINANCE (AT A DISTANCE) - FLUX OUT: 677.6 LM

3.28FT 1M	266.0, 563.2LX		5.70FT 173.90CM
6.56FT 2M	66.51, 140.8LX		11.41FT 347.80CM
9.84FT 3M	29.56, 62.58LX		17.11FT 521.70CM
13.12FT 4M	16.63, 35.20LX		22.82FT 695.60CM
16.40FT 5M	10.64, 22.53LX		28.53FT 869.50CM
19.69FT 6M	7.390, 15.64LX		34.23FT 1043.41CM
22.97FT 7M	5.429, 11.49LX		39.94FT 1217.31CM
26.25FT 8M	4.157, 8.800LX		45.64FT 1391.21CM
29.52FT 9M	3.284, 6.953LX		51.35FT 1565.11CM
32.80FT 10M	2.660, 5.632LX		57.05FT 1739.01CM
HT	EAVG/EMAX	ANGLE: 82.01DEG	DIA

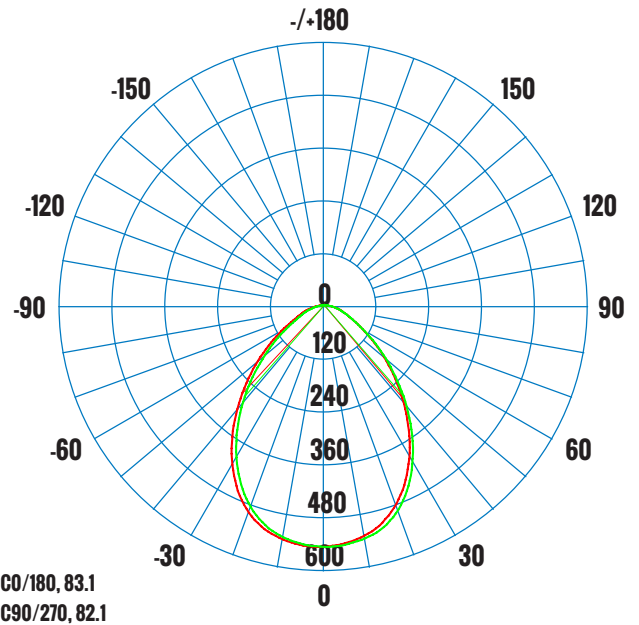
LUMINOUS INTENSITY DISTRIBUTION DIAGRAM

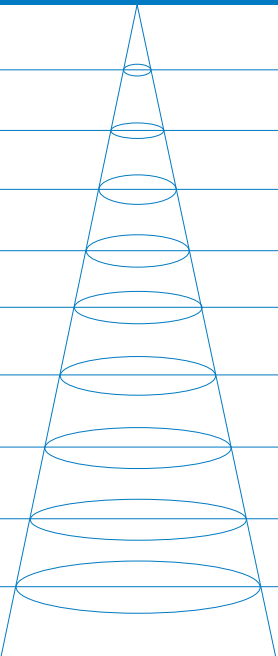
AVERAGE BEAM ANGLE(50%) - 82.6 DEG
LUMINAIRE PHOTOMETRIC (TEST REPORT) - 12W - 3500K
ILLUMINANCE (AT A DISTANCE) - FLUX OUT: 705.4LM

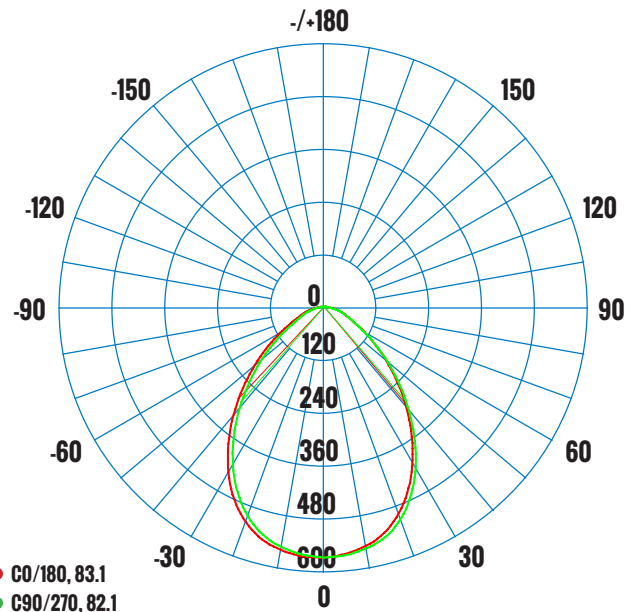
3.28FT 1M	277.0, 586.1LX		5.727FT 174.21CM
6.56FT 2M	69.24, 146.5LX		11.43FT 348.41CM
9.84FT 3M	30.77, 65.12LX		17.15FT 522.62CM
13.12FT 4M	17.31, 36.63LX		22.86FT 696.83CM
16.40FT 5M	11.08, 23.44LX		28.58FT 871.04CM
19.69FT 6M	7.694, 16.28LX		34.29FT 1045.24CM
22.97FT 7M	5.652, 11.96LX		40.00FT 1219.45CM
26.25FT 8M	4.328, 9.157LX		45.73FT 1393.66CM
29.52FT 9M	3.419, 7.236LX		51.43FT 1567.87CM
32.80FT 10M	2.770, 5.861LX		57.15FT 1742.07CM
HT	EAVG/EMAX	ANGLE: 82.11DEG	DIA

LUMINOUS INTENSITY DISTRIBUTION DIAGRAM

AVERAGE BEAM ANGLE(50%) - 82.6 DEG

PRODUCT CODE: DLCLR4-5812WCO-WH-FB

4 INCH LED COMMERCIAL RECESSED DOWNLIGHT / MULTI-WATTAGE / 3CCT



LUMINAIRE PHOTOMETRIC (TEST REPORT) - 12W 4000K

ILLUMINANCE (AT A DISTANCE) - FLUX OUT: 673.6 LM

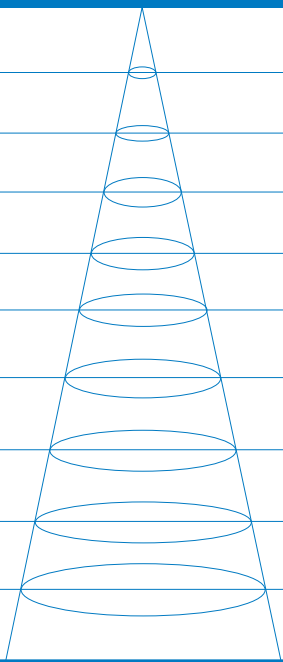
3.28FT 1M	264.5, 559.1LX		5.72FT 174.39CM
6.56FT 2M	66.12, 139.8LX		11.44FT 348.78CM
9.84FT 3M	29.39, 62.12LX		17.16FT 523.17CM
13.12FT 4M	16.53, 34.94LX		22.89FT 697.57CM
16.40FT 5M	10.58, 22.36LX		28.61FT 871.96CM
19.69FT 6M	7.347, 15.53LX		34.33FT 1046.35CM
22.97FT 7M	5.398, 11.41LX		40.05FT 1220.74CM
26.25FT 8M	4.133, 8.735LX		45.77FT 1395.13CM
29.52FT 9M	3.265, 6.902LX		51.50FT 1569.52CM
32.80FT 10M	2.645, 5.591LX		57.21FT 1743.92CM
HT	EAVG/EMAX	ANGLE: 82.17DEG	DIA

LUMINOUS INTENSITY DISTRIBUTION DIAGRAM

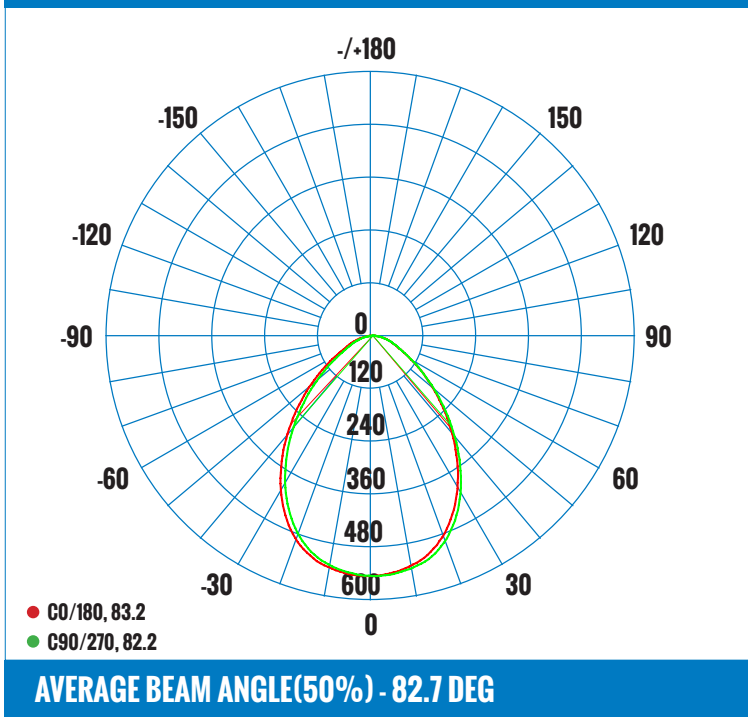

CERTIFICATIONS



DRIVER / LED CHIP



ACCESSORIES



SNAP-ON TRIM 4", BLACK
PART# DLCLTM4-BL
SNAP-ON TRIM 4" SILVER
PART# DLCLTM4-SI



GOOF RING, WHITE
OVERALL DIA. 8 1/2"
PART# DLCLR4-WH

PRE-MOUNTING PLATE - T-GRID CEILING FOR DLCLR4, DLCLR6 AND DLCLR8



PART NO#: DLCLRMP-TG

PRE-MOUNTING PLATE - STUD / JOIST CEILING FOR DLCLR4, DLCLR6 AND DLCLR8

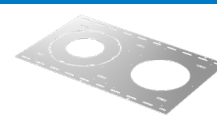

PART NO#: DLCLRMP-SJ

ORDERING INFORMATION - DLCLR SERIES

SERIES	SHAPE	SIZE	WATTAGE	VOLTAGE	COLOR TEMPERATURE	DIMMABLE	COLOR	LENS
E.G. DLCL	R	4	5812	W	C	0	WH	FB
DLCL - COMMERCIAL	R - ROUND	4 - 4"	5 - 5.5W	W - 120 - 347V	C - CHANGEABLE	0 - 10V CONTINUOUS	WH - WHITE	FB- FROSTED LENS
DOWNLIGHT			8 - 8W		3000K, 3500K, 4000K	DIMMING		AND BAFFLE
			12 - 12W					

IF PRE-MOUNTING PLATE IS REQUIRED FOR NEW CONSTRUCTION PROJECTS, PLEASE QUOTE: PART NO#: DLCLRMP-TG OR DLCLRMP-SJ WHEN ORDERING.

Head Office - 1850 Wilson Ave. · Toronto, ON · M9M 1A1 · Tel: 416.741.7336 · Fax: 416.741.9104

Toll Free: in Canada. 1.800.661.9610 · in USA. 1.888.762.5384 (SOCKETS4U)

www.etlin-daniels.com · For sales/service questions · sales@etlin.com