

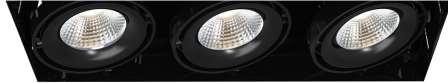

TE223LED, 3-LIGHT TRIMLESS LED MULTIPLE RECESS

PRODUCT DETAILS

No.	:	TE223LED-35-4-01
Product Color	:	BLACK
Length	:	18.375"
Width	:	6.25"
Height	:	7"



TECHNICAL DETAILS

Driver	:	Inventronics 35W Current Driver
Location	:	DRY
Approval	:	
Beam Angle	:	40
Cut Hole Length	:	18.625"
Cut Hole Width	:	6.5"

Options Available

ITEM NO.	FINISH	SHADE
TE223LED-35-4-01	BLACK	
TE223LED-35-4-02	WHITE	

LIGHT SOURCE DETAILS

Number of Bulbs	:	3
Light Source	:	LED
Light Source Type	:	LED
Input Voltage	:	120V
Socket Type	:	LED
Wattage	:	26W
Total Lumen	:	2500lm
Kelvin	:	3500K
CRI	:	90
Bulb Included	:	Yes
Dimmable	:	Yes

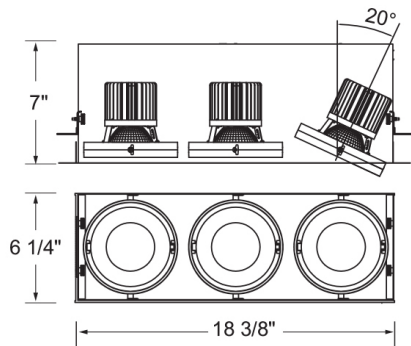

PROJECT INFORMATION

Job Name: Date: Type:

Comments: