

# INSTRUCTIONS

## VF2500-6L-CH

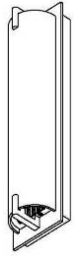

NOTE: This fixture can be mounted horizontally or vertically.

### Safety Instructions

- Follow and save these instructions.
- Always disconnect power at circuit breaker.
- If in doubt, contact a qualified electrician.

### Instructions de sécurité

- Suivez et garder ces instructions.
- Débranchez toujours le courant au di.

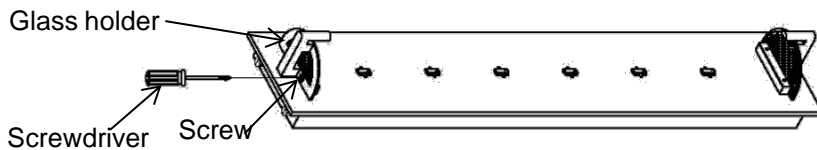

Remove glass holder from one end of fixture.  
Enlevez le support de verre d'un bout du luminaire.

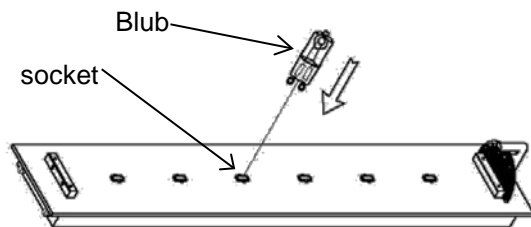

Insert the G9 bulbs.  
Insérez l'ampoule G9.

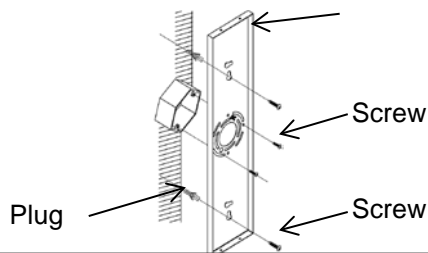

Attach back plate.  
Fixez la plaque arrière.

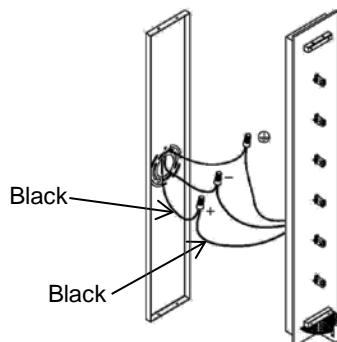

Make wiring connections,  
black wire from fixture to black wire from junction box.  
white wire from fixture to white wire from junction box.  
Connect the copper ground wire to ground wire from junction box.  
Faire les connexions électriques,  
le fil noir du luminaire au fil noir de la boîte de jonction.  
le fil blanc du luminaire au fil blanc de la boîte de

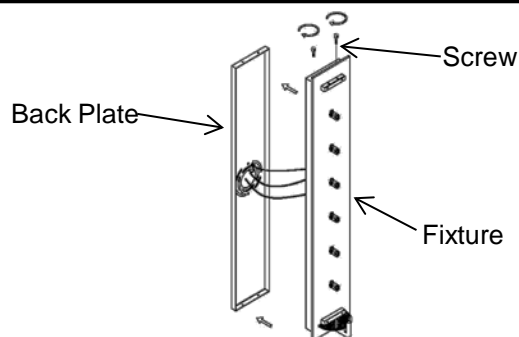

Attach fixture to the back plate, using screws provided.  
fixure Joindre à la plaque arrière, à l'aide des vis fournies.

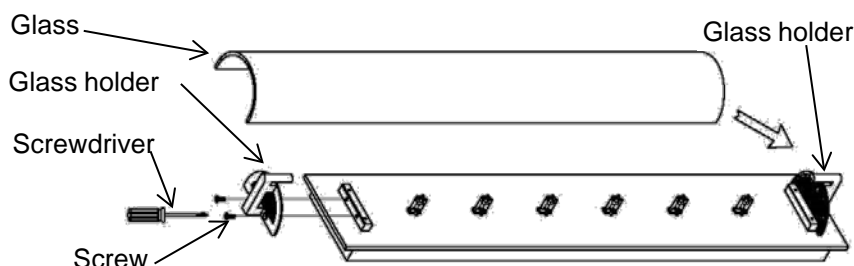

Insert the glass shade into the glass holder on fixture.  
Insérez le diffuseur en verre sur le verre, il bracket. Then serrer la vis.