

Project
Schedule / Date
Notes
Catalog Number

**Product Description**

naturalLED<sup>®</sup> (SCM) Slim canopy is DLC Premium listed and UL listed for wet locations with a rating of IP65. Aesthetically pleasing construction, low-profile design with die-cast aluminum housing and shatter-resistant polycarbonate prismatic lens.

Dustproof, sealed structure, 1/2" threaded conduit entrances on each side. This fixture comes with or without an integral microwave occupancy sensor, factory mounted behind the lens. The microwave occupancy sensor has multiple sensor settings that can be selected via dip switch at the sensor brain inside the fixture which include: daylight sensing, step dimming, area sensitivity, standby time and on/off.



**Features & Benefits**

- ▶ DLC Premium Qualified
- ▶ IP65 Rated
- ▶ Multiple sensor settings
- ▶ Long life LED chips
- ▶ Uniform and consistent color
- ▶ Excellent thermal design
- ▶ Shatter-resistant polycarbonate lens
- ▶ Finish: Aluminum die-cast

**Color Choices**



**Specifications**

- ▶ Input line voltage: 120-277V
- ▶ Powerfactor >0.9
- ▶ Operating temperature: -22°F ~ 122°F
- ▶ 50,000 hrs rated average life

**Applications**

- ▶ Security Lighting
- ▶ Pathway Lighting
- ▶ Ceiling Lighting
- ▶ Parking Lighting



Ordering Information

Code	Description	CCT	Watt	Lumen	Equiv Wattage	Color	Beam Angle	Sensor	Rated Hrs	IP65	DLC	
Microwave Motion Sensor	7489	LED-FXSCM28/40K/BK-SEN	4000K	28	3,236	150	Black	160°	Yes	50,000	•	•
	7490	LED-FXSCM28/50K/BK-SEN	5000K	28	3,375	150	Black	160°	Yes	50,000	•	•
	7491	LED-FXSCM42/40K/BK-SEN	4000K	42	4,871	175	Black	160°	Yes	50,000	•	•
	7492	LED-FXSCM42/50K/BK-SEN	5000K	42	5,003	175	Black	160°	Yes	50,000	•	•
	7493	LED-FXSCM59/40K/BK-SEN	4000K	59	6,800	250	Black	160°	Yes	50,000	•	•
	7494	LED-FXSCM59/50K/BK-SEN	5000K	59	6,985	250	Black	160°	Yes	50,000	•	•
	7480	LED-FXSCM28/50K/WH-SEN	5000K	28	3,375	150	White	160°	Yes	50,000	•	•
	7482	LED-FXSCM42/50K/WH-SEN	5000K	42	5,003	175	White	160°	Yes	50,000	•	•
	7484	LED-FXSCM59/50K/WH-SEN	5000K	59	6,985	250	White	160°	Yes	50,000	•	•
	7468	LED-FXSCM28/40K/BK	4000K	28	3,236	150	Black	160°	-	50,000	•	•
7469	LED-FXSCM28/50K/BK	5000K	28	3,375	150	Black	160°	-	50,000	•	•	
7470	LED-FXSCM42/40K/BK	4000K	42	4,871	175	Black	160°	-	50,000	•	•	
7471	LED-FXSCM42/50K/BK	5000K	42	5,003	175	Black	160°	-	50,000	•	•	
7472	LED-FXSCM59/40K/BK	4000K	59	6,800	250	Black	160°	-	50,000	•	•	
7473	LED-FXSCM59/50K/BK	5000K	59	6,985	250	Black	160°	-	50,000	•	•	
7495	LED-FXSCM28/40K/WH	4000K	28	3,236	150	White	160°	-	50,000	•	•	
7496	LED-FXSCM28/50K/WH	5000K	28	3,375	150	White	160°	-	50,000	•	•	
7497	LED-FXSCM42/40K/WH	4000K	42	4,871	175	White	160°	-	50,000	•	•	
7498	LED-FXSCM42/50K/WH	5000K	42	5,003	175	White	160°	-	50,000	•	•	
7499	LED-FXSCM59/40K/WH	4000K	59	6,800	250	White	160°	-	50,000	•	•	
7500	LED-FXSCM59/50K/WH	5000K	59	6,985	250	White	160°	-	50,000	•	•	

Accessories (available for purchase)

Drop Lens

**P10126 LENS-SCM/DR9X9**  
Slim Canopy Clear Drop Lens



**P10125 LENS-SCM/FR9X9**  
Slim Canopy Frosted Lens



Photometric Data

28 Watt- Slim Lens

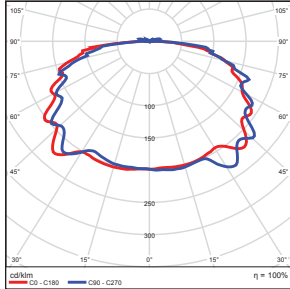

Zonal Lumen Summary

Zone	Lumens	% Luminaire
0-30	545.95	16.90
0-40	973.72	30.10
0-60	2033.15	62.80
60-80	939.05	29.00
70-80	433.05	13.40
90-120	37.98	1.20
90-180	43.04	1.30
0-180	3237.05	100.00

Total Luminaire Efficiency = 100.00%

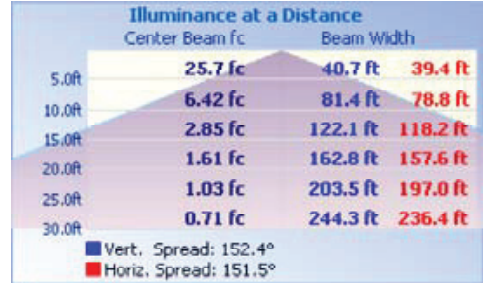

42 Watt- Slim Lens

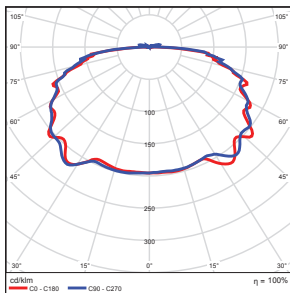

Zonal Lumen Summary

Zone	Lumens	% Luminaire
0-30	808.51	16.60
0-40	1450.8	29.80
0-60	3045.56	62.50
60-80	1425.98	29.30
70-80	653.33	13.40
90-120	54.92	1.10
90-180	63.28	1.30
0-180	4873.43	100.00

Total Luminaire Efficiency = 100.00%

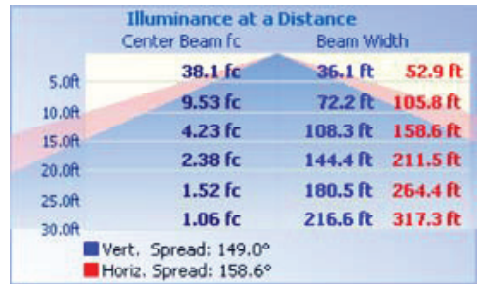

59 Watt- Slim Lens

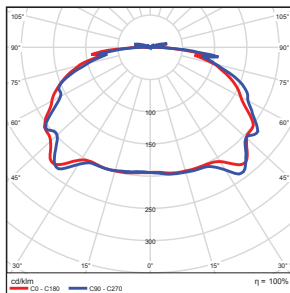

Zonal Lumen Summary

Zone	Lumens	% Luminaire
0-30	1154.02	17.00
0-40	2096.9	30.80
0-60	4418.05	65.00
60-80	1851.99	27.20
70-80	796.49	11.70
90-120	106.83	1.60
90-180	117.96	1.70
0-180	6801.88	100.00

Total Luminaire Efficiency = 100.00%

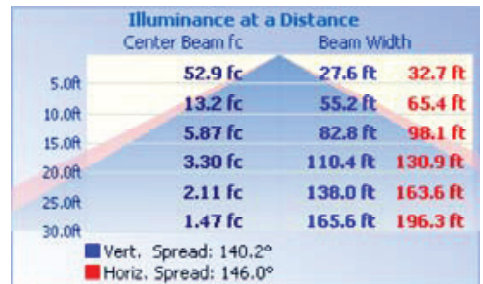

Photometric Data

28 Watt- Tall Lens

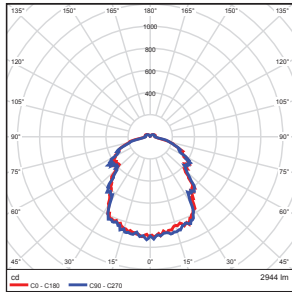

Zonal Lumen Summary

Zone	Lumens	% Luminaire
0-30	725.76	24.70
0-40	1180.00	40.10
0-60	2028.37	68.90
60-80	603.32	20.50
70-80	232.84	7.90
90-120	160.48	5.50
90-180	231.64	7.90
0-180	2944.02	100.00

Total Luminaire Efficiency = 100.00%

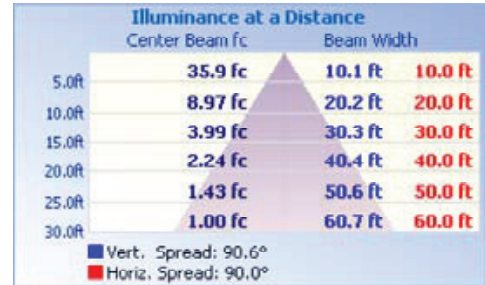

42 Watt- Tall Lens

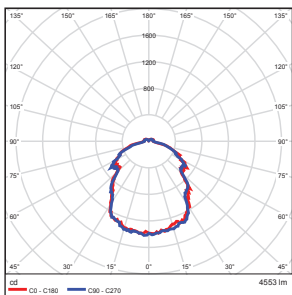

Zonal Lumen Summary

Zone	Lumens	% Luminaire
0-30	1121.56	24.60
0-40	1824.37	40.10
0-60	3140.64	69.00
60-80	929.66	20.40
70-80	355.68	7.80
90-120	248.18	5.50
90-180	358.05	7.90
0-180	4552.49	100.00

Total Luminaire Efficiency = 100.00%

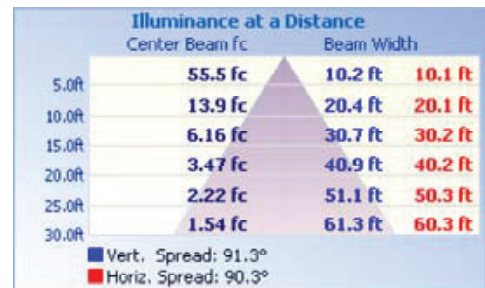

59 Watt- Tall Lens

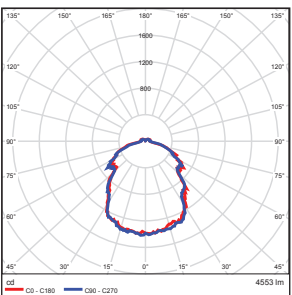

Zonal Lumen Summary

Zone	Lumens	% Luminaire
0-30	1442.75	25.20
0-40	2338.87	40.80
0-60	3988.9	69.60
60-80	1148.22	20.00
70-80	432.00	7.50
90-120	314.07	5.50
90-180	434.75	7.60
0-180	5731.02	100.00

Total Luminaire Efficiency = 100.00%

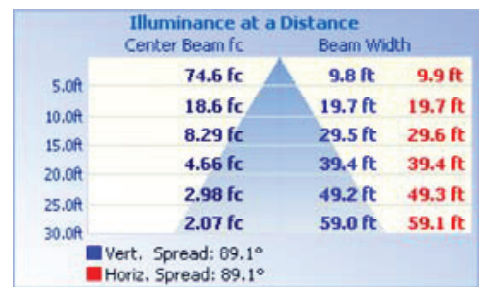

Product Dimensions

28-Watt

Weight: 4.50-lbs

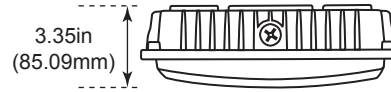
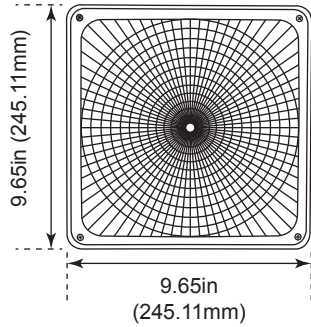

42/59-Watt

Weight: 5.10-lbs

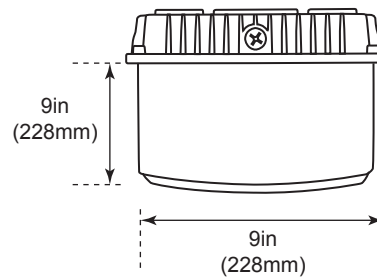
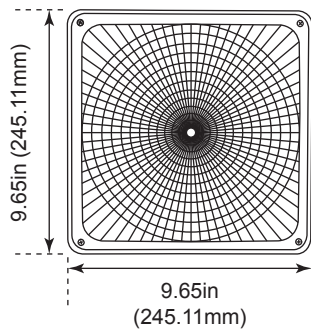

Package

