

MODEL HS- 3000NA

Description

- Thermoflow 3000W Heater
- Nominal voltage : 240V
- Frequency : 60Hz
- Nominal capacity : 3000W
- Protection class: I
- type of protection : IP65
- Dimensions : 1-15/16" x 6-1/2" x 72-7/16"
- Weight : 18.4lb

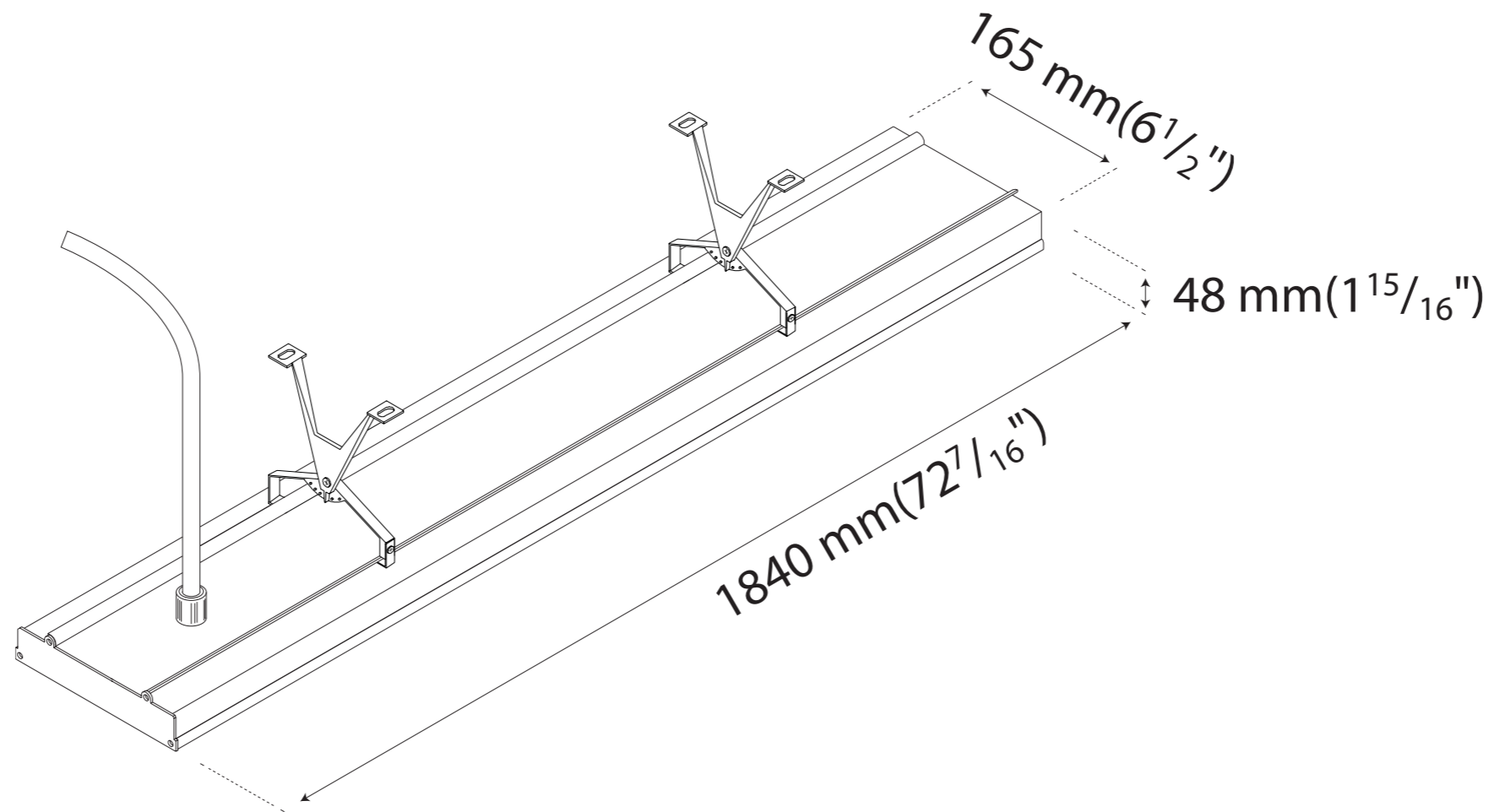

Reference	QTY.	Remarks	Project:
			Location:
			Architect:
			Engineer:
			Contractor:
			Submitted by:
			Date:

