

PREMISE

WP7 SERIES TRADITIONAL WALL PACK

INSTALLATION INSTRUCTIONS FOR

- WP7-304-1 | WP7-304-3
- WP7-504-1 | WP7-504-3
- WP7-804-1 | WP7-804-3
- WP7-1204-1 | WP7-1204-3



WHAT'S IN THE BOX

- WP7 fixture
- Photocell (120-277V models)
- Small bubble level
- Octagon foam pad
- 4 small circular foam pads



WHAT YOU'LL NEED

- Wiring supplies as per national and local electrical codes
- #2 Phillips screwdriver
- Drill with bit sized to fit mounting screws/hardware
- For conduit mount: mounting hardware/screws x 4

IMPORTANT

Before installing fixture, read all instructions and retain for future reference. The important instructions and safeguards that appear in this document are not inclusive of all possible conditions and situations that may occur. It must be understood that common sense, caution, and care are factors that cannot be built into a product. These factors must be supplied by those that care and operate the fixture.

For additional information required not covered in this document please contact a local representative.



WARNING AND SAFETY

- Risk of electric shock!
- Ensure power is OFF at the electrical panel before starting installation or maintenance
- Verify site supply voltage matches luminaire product label
- Ensure the cover is closed during operation
- Modifications to the product will void warranty
- Ambient temperature range under normal operation not to exceed
- -40°C to 50°C (-13°F to 122°F)
- Wiring to fixture must be in accordance with the National Electrical Code and all applicable local electrical and safety regulations

1

INSTALLATION

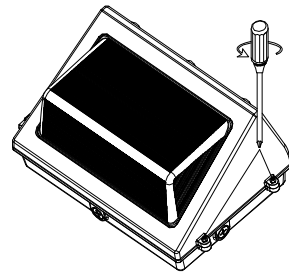

1 With a #2 Phillips screwdriver, loosen the cover screws

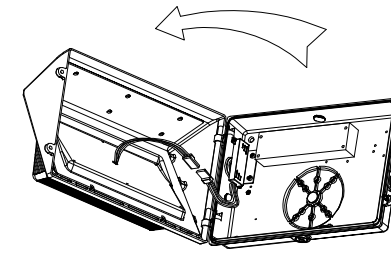

2 Open the fixture, unplug the connector from the cover and remove the upper cover from the back plate of the fixture

JUNCTION BOX WALL MOUNT

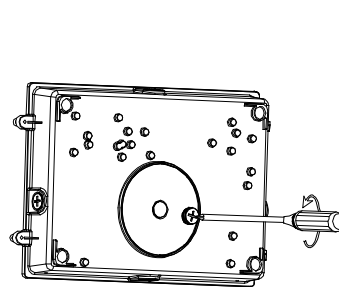

3 Use a large Phillips or flat-head screwdriver to remove the 1/2" threaded KO plug from the back plate

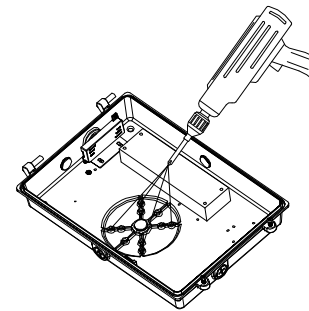

4 Drill holes through the back plate to match the junction box mounting screws required

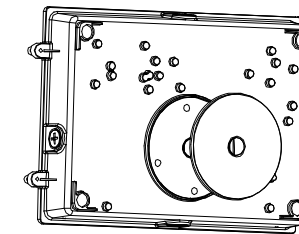

5 Peel and adhere large foam pad to back of mounting plate. Remove inner sections for screws

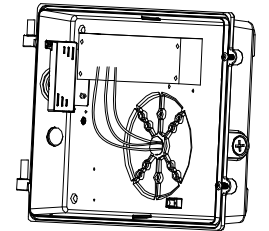

6 Thread the wire through the back plate plug hole

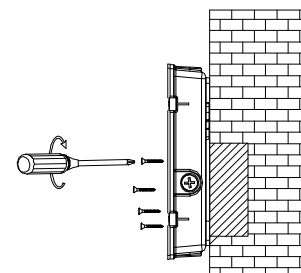

7 Level and secure the bottom shell on the octagon box with screws and the back plate bubble level

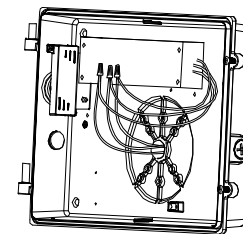

8 Connect fixture to the power supply as per the included wiring diagram

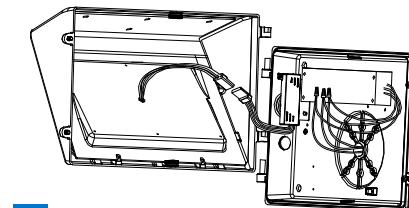

9 Hook the cover of the fixture onto the mounted back plate and reattach the cover connector

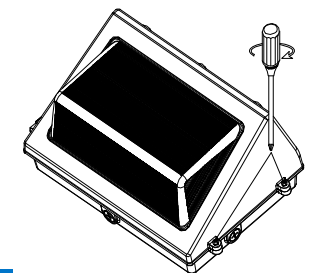

10 Ensuring uniform gasket coverage, close the cover and tighten Phillips screws to complete installation

2

CONDUIT WALL MOUNT

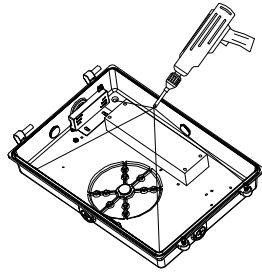

- 1** Drill holes through each of four corner mounting locations

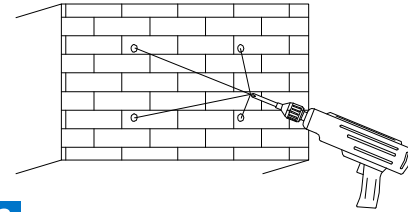

- 2** Using drilled out back plate as a guide, ensure level with included bubble, mark and drill holes for anchors

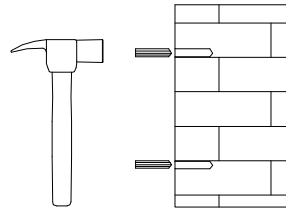

- 3** Insert anchors into drilled holes to match

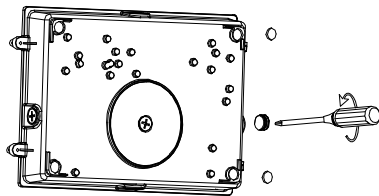

- 4** Remove an available 1/2" threaded KO plug to run conduit to. Peel and attach the 4 circular mounting pads

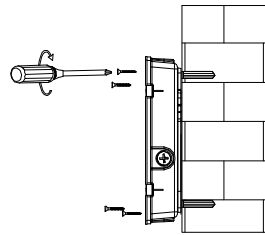

- 5** Level and secure the bottom shell with screws and the back plate bubble level

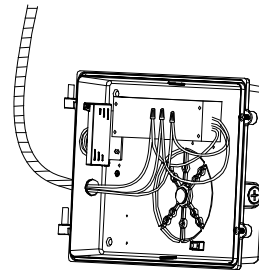

- 6** Run conduit to the fixture and connect fixture to the power supply as per the included wiring diagram

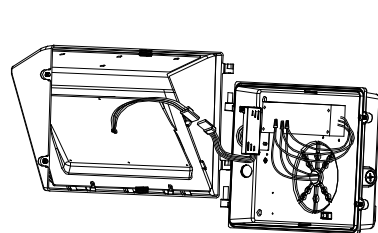

- 7** Hook the cover of the fixture onto the mounted back plate and reattach the cover connector

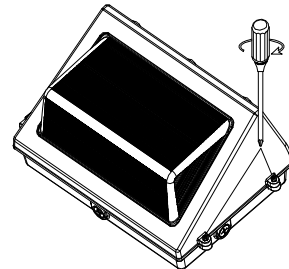

- 8** Ensuring uniform gasket coverage, close the cover and tighten Phillips screws to complete installation

WIRING SCHEMATIC FOR 120-277V MODELS

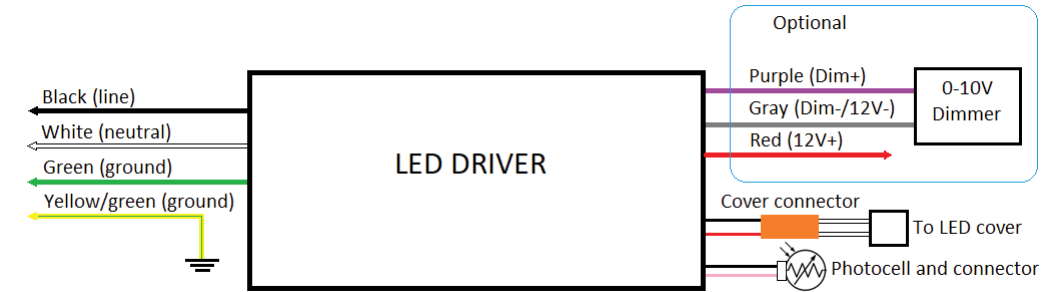

Photocell is installed in the hinge side knockout location and connected as per the wiring diagram.

DISABLE PHOTOCELL

Photocell is installed in the hinge side knockout location and connected as per the wiring diagram. To disable photocell, open fixture cover and unplug pink and black photocell wire connector.

MOVE PHOTOCELL

To move photocell to an alternate 1/2" threaded knockout location, first disconnect photocell as per above and gently unscrew and retain the photocell. Remove the 1/2" threaded knockout from the alternate location and close top photocell location. Gently screw photocell into new location and reattach photocell connector.

WIRING SCHEMATIC FOR 120-277/347V MODELS

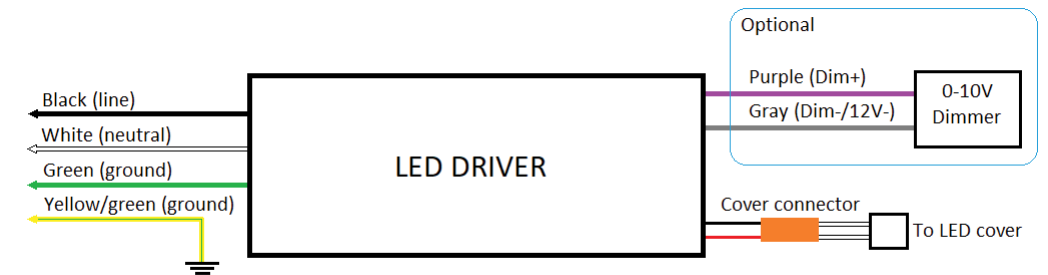

WIRE GUARD ACCESSORY (WP7-WG)

Optional accessory, purchased separately.

1. Attach wire guard to face of the cover using the included 4 screws
2. Works with WP7-SHIELD

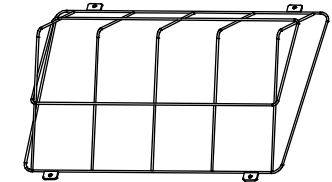

SHIELD ACCESSORY (WP7-SHIELD)

Optional accessory, purchased separately.

1. Attach shield to each side of the cover using the included 4 screws
2. Works with WP7-WG

