

SAFETY INFORMATION

Please read and understand this entire manual before attempting to assemble, install or operate the product.

WARNING

- RISK OF ELECTRIC SHOCK - Before beginning installation, turn off electricity at the circuit breaker box or the main fuse box.
- RISK OF FIRE - Use bulbs specified by the markings and/or labels on the fixture.

CAUTION

- For your safety, read instructions completely before beginning installation.
- If in doubt about electrical installation, consult a licensed electrician.
- Turn off electricity to fixture before replacing the bulb(s).

TOOLS REQUIRED



CARE AND MAINTENANCE

- Wipe clean using soft, dry cloth or static duster. Always avoid using harsh chemicals and abrasives to clean fixture as they may damage the finish.

If you need further assistance call Quozel Customer Care at 1-800-645-3184 (9:00am - 5:00pm EST), or visit us on-line at www.quezel.com.

PACKAGE CONTENTS

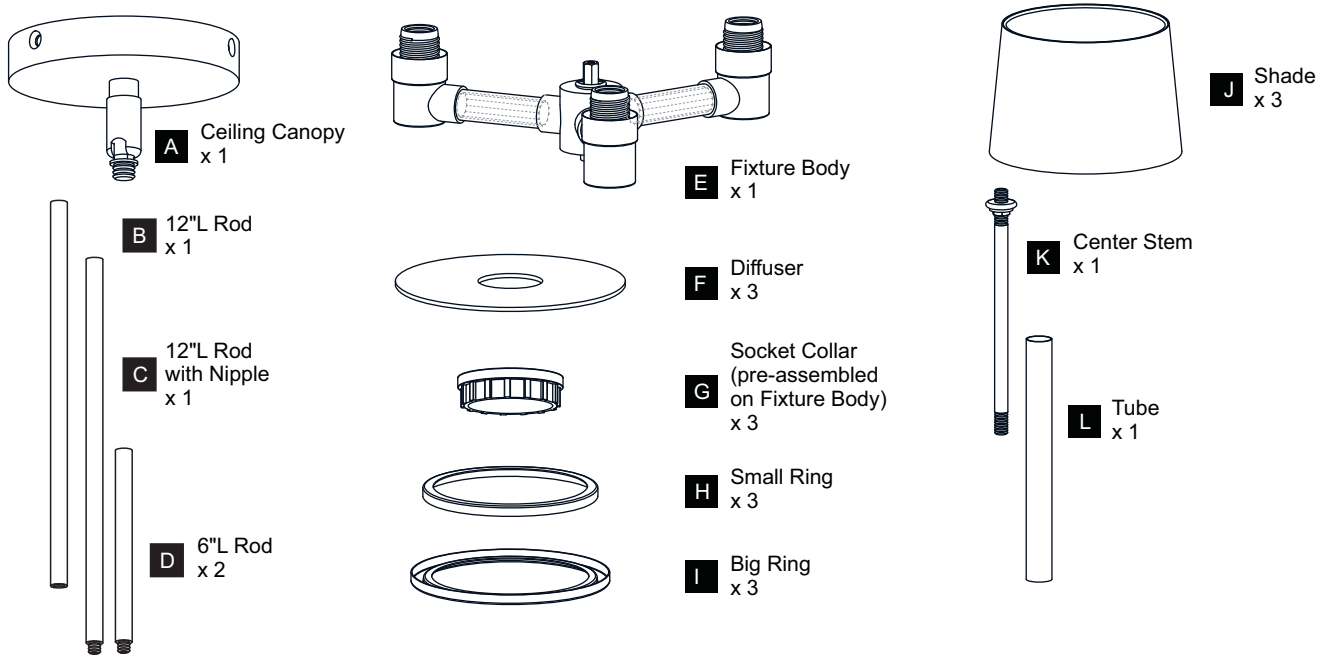

MOUNTING HARDWARE

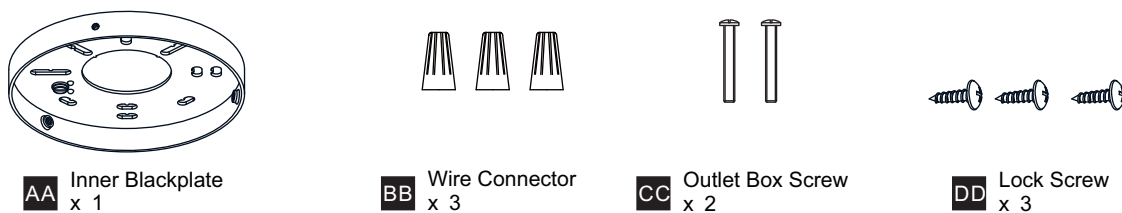

INSTALLATION

OPTION 1: PENDANT KYL2822MBK

1 Install Center Stem and Tube

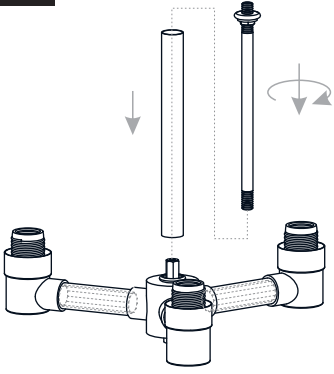

2 Install Rods

Optional Rods:
8 Feet Ceiling:
(2) 12"L Rods.
9 Feet Ceiling:
(2) 6"L Rods + (2) 12"L Rods.

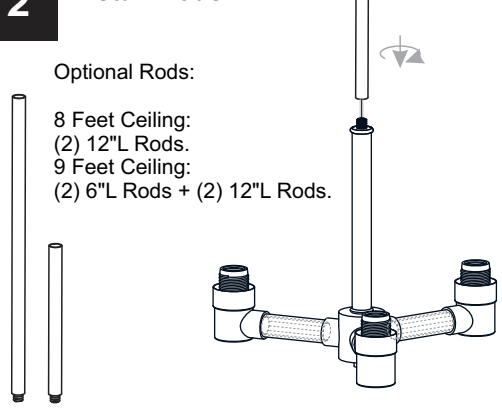

3 Tighten hex nut inside of the ceiling canopy

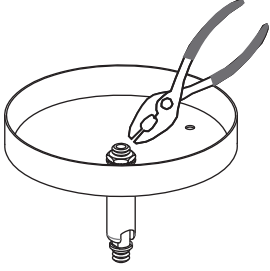

4 Install Ceiling Canopy to Upper Rod

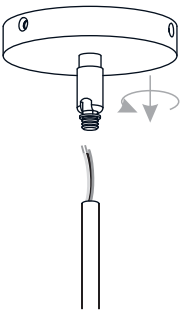

5 Install Crossbar Assembly

Outlet Box

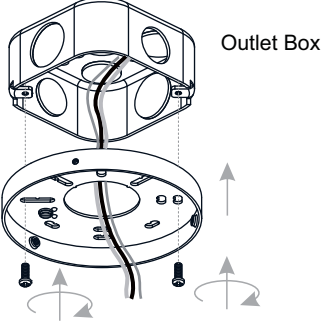

6 Wiring

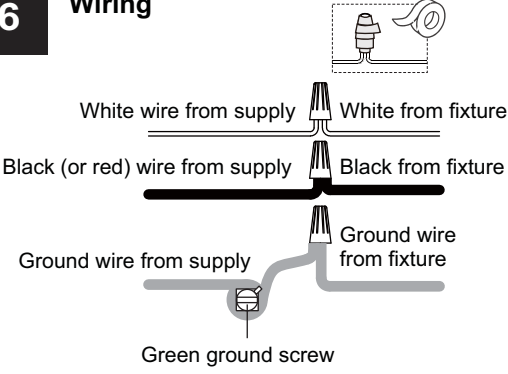

White wire from supply White from fixture
Black (or red) wire from supply Black from fixture
Ground wire from supply Ground wire from fixture
Green ground screw

7 Install Ceiling Canopy to Inner Backplate

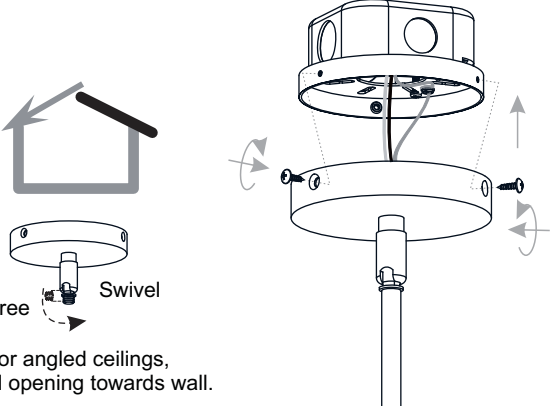

90Degree Swivel
For angled ceilings, Swivel opening towards wall.

8 Install Diffusers

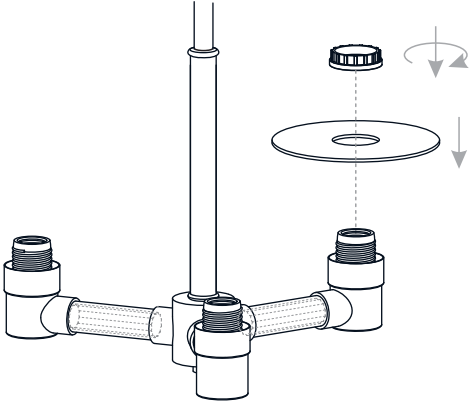

9 Install Shades

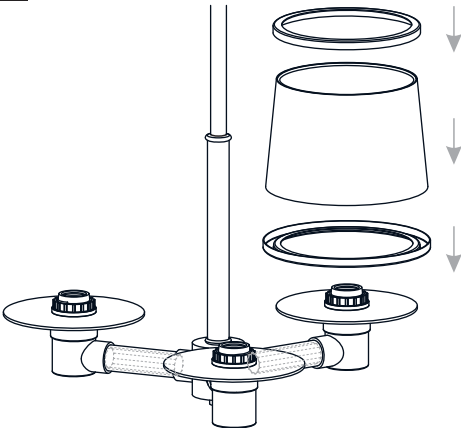



10 Install Bulbs

Install three correct bulbs referring to fixture markings and/or labels for maximum wattage.

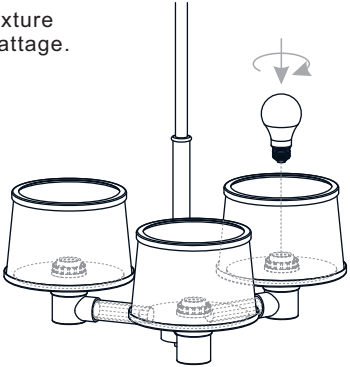
Recommended Bulb Type (not included):



 BULB BASE TYPE Medium (E26) |  BULB TYPE TYPE A

100W MAX

INSTALLATION

OPTION 2: SEMI-FLUSH KYL1722MBK

* Set aside the (2) 6"L Rods and (2) 12"L Rods since they are not required for the semi-flush installation.

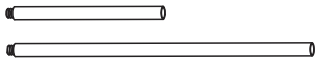

1 Remove Swivel

Set aside swivel

2 Install Center Stem and Tube

3 Install Ceiling Canopy

4 Install Crossbar Assembly

Outlet Box

5 Wiring

White wire from supply White from fixture
Black (or red) wire from supply Black from fixture
Ground wire from supply Ground wire from fixture
Green ground screw

6 Install Ceiling Canopy to Inner Backplate



7 Install Diffusers

8 Install Shades

9 Install Bulbs

Install three correct bulbs referring to fixture markings and/or labels for maximum wattage.

Recommended Bulb Type (not included):

 BULB BASE TYPE Medium (E26)	 BULB TYPE TYPE A
---	--

Your installation is now complete! Restore electricity and save this sheet for future reference.