

Please go to [www.quoizel.com](http://www.quoizel.com) for product cleaning tips. Go to the **Care + Maintenance** selection.

**Tools Required:** Flathead screwdriver, Phillips screwdriver, pliers, wire cutters, wire strippers, electrical tape, safety glasses.

**Light Source:** (5) A19 Medium Base Vintage Bulbs 100W Maximum, bulbs included.

**Fixture Hanging Height:** Minimum Hanging Height is 11.75", Maximum Hanging Height is 49.75".

**Estimated Assembly Time:** 30-45 minutes

**Preparation:** Identify and inspect all parts before beginning installation. Check package content list and diagrams below to be sure all parts are present. If any parts are missing or damaged, do not attempt to assemble, install, or operate the fixture. Contact your original place of purchase.

**Note:** This **CONVERTIBLE** fixture can be mounted as pendant light or semi-flush light. Refer to respective installation steps for installations.

### ⚠ Warnings and Cautions

Turn off electricity at circuit breaker or main fuse box before installation. Consult a licensed electrician if in doubt.

These instructions are provided for your safety. It is very important you read them completely before installing the fixture. We strongly recommend that a licensed, professional electrician perform the installation.

Disconnect fixture from power source before replacing bulbs. Make sure bulbs are given sufficient time to cool before removal.

### Package Contents

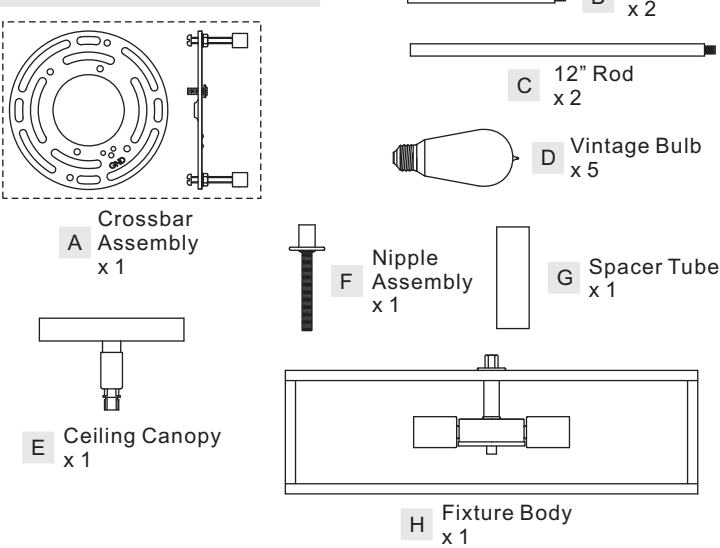

### STEP 2A - Install Ceiling Canopy, Rods and Nipple together

- A. Tighten the hex nut inside of the Ceiling Canopy (E).
- B. Determine the Rods (B/C) to be assembled to the Nipple (F) according to your hanging height.
- C. Pass the supply wires and ground wire through the chosen rods (B/C) and the Ceiling Canopy (E). Thread the Nipple (F), the chosen Rods (B/C) and the Ceiling Canopy (E) together. Hand tighten until snug.

Suggested rods for Ceiling height:  
 8' ceiling : use (2) 12" rods  
 9' ceiling : use (2) 6" rods and (2) 12" rods

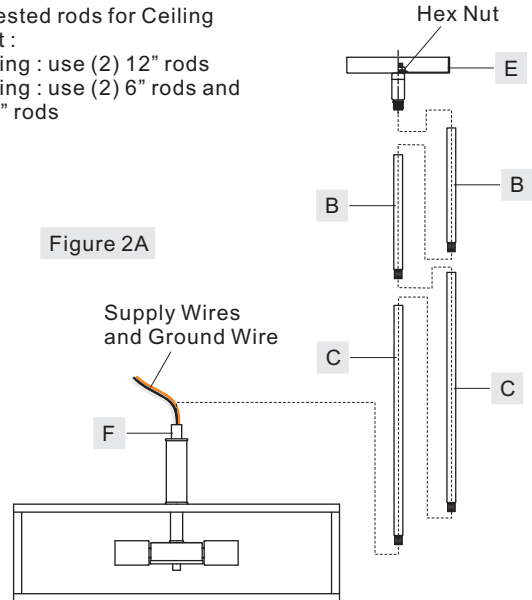

### Assembly Instructions for Pendant Light: NHR2820WT and NHR2820BN (Step 1A - Step 7A)

#### STEP 1A - Install Nipple and Spacer Tube

- A. Place the Spacer Tube (G) over the hex coupling on the top center of the Fixture Body (H). Thread the Nipple Assembly (F) onto the hex coupling on the Fixture Body (H) and hand tighten until snug to secure the Spacer Tube (G).

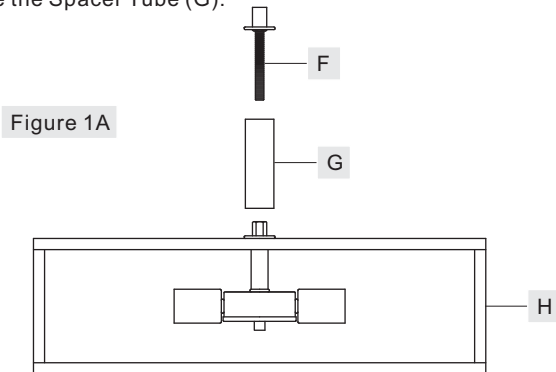

#### STEP 3A - Installing the Crossbar Assembly

- A. Pass the supply wires from outlet box through the Crossbar Assembly (A). Attach the Crossbar Assembly (A) to the outlet box with the head of the green ground screw facing you. Secure the Crossbar Assembly (A) with outlet box screws (not included). Tighten until snug.

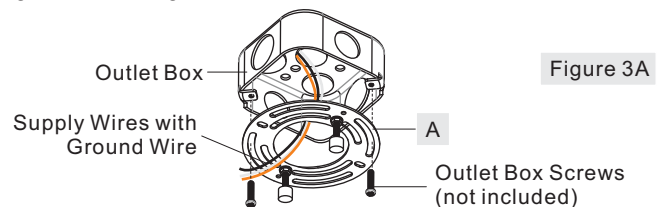

### STEP 4A – Test Fitting Ceiling Canopy to Crossbar Assembly

A. Remove mounting balls from the Crossbar Assembly (A). Fit the Ceiling Canopy (E) to the Crossbar Assembly (A) and secure with mounting balls. Note: The Ceiling Canopy (E) should be snug against the ceiling and the mounting balls. If not, adjust the length of the nipple on the Crossbar Assembly (A) by unscrewing the preassembled hex nut and lock washer and then screwing the mounting screws in or out of the crossbar until the correct length is achieved. Once the Ceiling Canopy (E) is secure, remove the mounting ball and Ceiling Canopy (E).

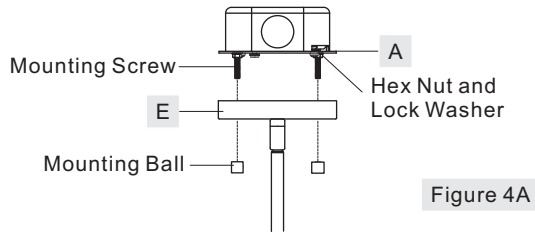

Figure 4A

### STEP 5A - Wire Connections

A. Wrap bare or green ground wire around green ground screw on the crossbar, no less than 2 inches from the end of the wire. Tighten the green ground screw.  
 B. Use standard wire connectors (not included) to make all wire connections. Twist connectors until wires are tightly joined together. Wrap each connection with approved electrical tape and carefully stuff all the connected wires into the Outlet Box.

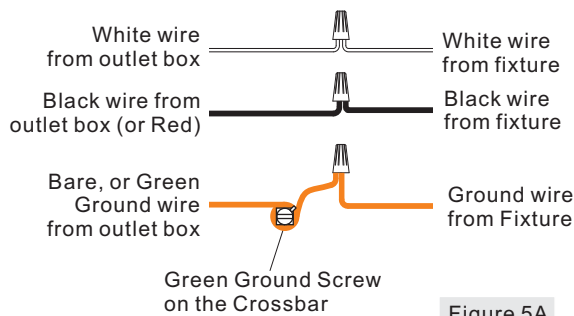

Figure 5A

### STEP 6A – Install the Fixture

A. Carefully tuck all wires into the outlet box and position the Ceiling Canopy (E) over the outlet box. Align the holes in the Ceiling Canopy (E) with the mounting screws, then attach the Ceiling Canopy (E) using the previously removed mounting balls. Hand tighten until snug.

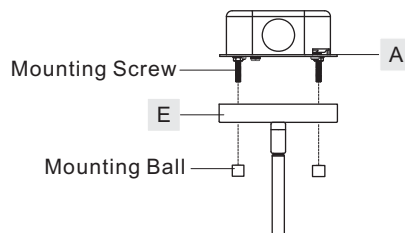
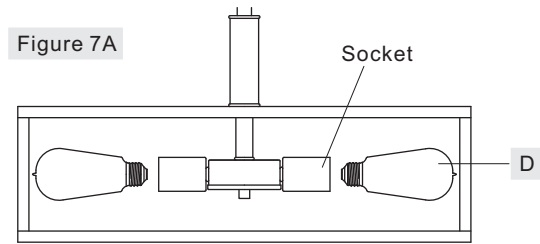

Figure 6A

### STEP 7A – Install Bulbs

A. Insert Bulbs (D) onto sockets and screw snugly into place.

Your fixture is now assembled and ready to use. Enjoy!



### Assembly Instructions for Semi-Flush Light: NHR1720WT and NHR1720BN (Step 1B - Step 2B)

The following parts will not be used in the assembly of the Semi-Flush Light fixture. Please set aside these parts.

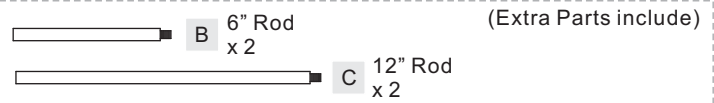

### STEP 1B – Remove Swivel

A. Unlock the hex nut inside of the Ceiling Canopy (E). Remove the lock washer, the flat washer and the ceiling canopy from the swivel.  
 B. Remove the nipple from the swivel and set aside the swivel since it will not be used for the installation.

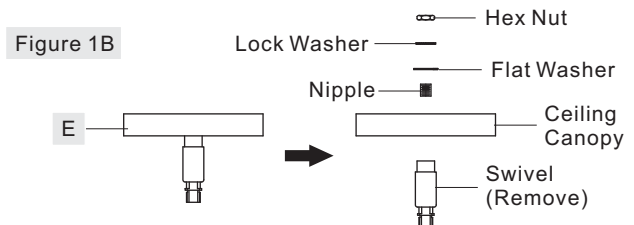

### STEP 2B – Install Nipple, Spacer Tube and Ceiling Canopy

A. Pass the supply wires and ground wire through the Tube (G), the Nipple Assembly (F), the ceiling canopy, the nipple, the flat washer, the lock washer and the hex nut in turn.  
 B. Place the Spacer Tube (G) over the hex coupling on the top center of the Fixture Body (H). Thread the Nipple Assembly (F) onto the hex coupling on the Fixture Body (H) and hand tighten until snug to secure the Spacer Tube (G).

C. Thread the previously removed nipple onto the Nipple Assembly (F). Place the ceiling canopy, the flat washer and the lock washer over the nipple and secure with previously removed hex nut. Hand tighten until snug with pliers.  
 D. Cut the wires leaving approximately 6" of wire extending from the ceiling canopy.  
 E. Go to Step 3A - Step 7A to complete installations.

Figure 2B

